



H8DA

MULTI-FUNCTION
DIGITAL COUNTER / TIMER
User's Manual

RESTRICTIONS ON USE

When using this product in applications that require particular safety or when using this product in important facilities, please pay attention to the safety of the overall system and equipment. Install fail-safe mechanisms, perform redundancy checks and periodic inspections and adopt other appropriate safety measures when it is necessary.

SAFETY PRECAUTION

This manual uses the following symbols to ensure safe operation of this timer.

- WARNING** Warnings are indicated when mishandling this product might result in death or serious injury to user.
- CAUTION** Cautions are indicated when mishandling this product might result in minor injury to the user, or only physical damage to the timer.

WARNING

- Note this incorrect wiring of this product can damage it and lead to other hazards. Make sure the product has been correctly wired before turning the power ON.
- Before wiring, or removing / mounting the product, be sure to turn the power OFF. Failure to do so might cause electric shock.
- Do not touch electrically charged parts such as the power terminals. Doing so might cause electric shock.
- Do not disassemble the product. Doing so might cause electric shock or faulty operation.

CAUTION

- Use the product within the operating ranges recommended in the specification (temperature, humidity, voltage, shock, mounting direction, atmosphere etc.). Failure to do so might cause fire or faulty operation.
- Firmly tighten the wires to the terminal. Insufficient tightening of the wires to the terminal might cause fire.

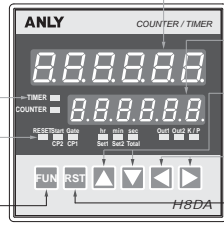
SPECIFICATIONS		NAMES AND FUNCTIONS OF FACEPLATE	
Operating voltage	AC/DC : 12~48V / AC/DC : 100~240V	<p>LEDs COUNTER(TIMER): Counting (Timing)indicator RESET: Reset indicator Start: Start signal input indicator Gate: Gate signal input indicator hr, min, sec: Time unit indicator Out1, Out2: Control output 1, 2 indicator K/P: Key protection indicator CP1, CP2: Signal input 1, 2 indicator Set1, Set2: 1st, 2nd set value indicator Total: Total value indicator FUN key Switch to the different mode. Hold down for at least 3 seconds to enter setting modes.</p> 	Upper display Display PV values (current values, etc.) or setup items.
Allowable operating voltage range	85 ~ 110% of rated operating voltage		Lower display Display SV values (Set values, etc.) and other parameter values.
Rated frequency	50 / 60Hz		▲▼ key Used for incrementing or decrementing numeric values. And show the first set value or second set value.
Contact rating	250VAC 5A (Resistive load)		↔ key Performing arithmetic shift operations and switches the display.
Count speed	MAX 30, 1k, 5k or 10k cps		SET key Reset the output or save the value of setting.(after save than back to the operation mode)
Power consumption	Approx. 3.5VA		
Life	Mechanical : 5,000,000 times / Electrical : 100,000 times		
Ambient temperature	-10 ~ +50°C		
Ambient humidity	MAX 85% RH		
Weight	Approx. 260g		

SETTING PROCEDURE

COUNTER OR TIMER'S VALUES RESET	SWITCH TO THE MODE SETTING STATUS	SWITCH TO THE NEXT MODE	SAVE AND BACK TO THE OPERATION STATUS
POWER ON or RST	FUN + 3 Sec	FUN	RST
Counter:			
1.INPUT MODE 1-1 UP 1-5 UP/DOWN C 1-2 DOWN 1-3 UP/DOWN A 1-4 UP/DOWN B	2.OUTPUT MODE 2-1 Mode N 2-5 Mode K 2-9 Mode L 2-2 Mode F 2-6 Mode P 2-R Mode H 2-3 Mode C 2-7 Mode Q 2-4 Mode R 2-8 Mode A	2A.UP/DOWN COUNTING RANGE 2A-1 -99999(-99999-99999) 2A-2 0(0-999999) 2A-3 999999(0-999999 cycle)	3.OUTPUT 2 TIME 3-1 0.01S 3-5 0.5S 3-9 10S 3-2 0.05S 3-6 1S 3-R 20S 3-3 0.1S 3-7 2S 3-4 0.2S 3-8 5S
4.OUTPUT 1 TIME 4-1 Hold 4-5 0.2S 4-9 5S 4-2 0.01S 4-6 0.5S 4-R 10S 4-3 0.05S 4-7 1S 4-b 20S 4-4 0.1S 4-8 2S	5.COUNT SPEED 5-1 30 cps 5-2 1k cps 5-3 5k cps 5-4 10k cps	6.MINIMUM RESET TIME 6-1 20mS 6-2 1mS	7.DECIMAL POINT 7-1 999999 7-5 99.9999 7-2 99999.9 7-3 9999.9 7-4 999.999
8.PRESCALE VALUE 8-1 0.0001-99.9999	9.KEY PROTECTION LEVEL 9-1 Lock function key FUN 9-2 Lock reset key RST 9-3 Lock preset value key ▲▼↔ 9-4 Lock all key	10.POWER OFF MODE R-1 Power off reset R-2 Power off memory	11.NPN/PNP INPUT MODE 12.FUNCTION MODE b-1 nPn b-2 PnP C-1 Counter C-2 Timer
Timer:			
1.TIME RANGE 1-1 999.999S 1-5 99M59.99S 1-9 99H59M59S 1-2 9999.99S 1-6 999M59.9S 1-R 9999H59M 1-3 99999.9S 1-7 99999.9M 1-b 99999H59M 1-4 999999S 1-8 999999M 1-C 999999H	2.UP / DOWN MODE 2-1 Count up 2-2 Count down	3.OUTPUT MODE 3-1 Mode A 3-5 Mode B 3-9 Mode D 3-2 Mode A1 3-6 Mode B1 3-R Mode E 3-3 Mode A2 3-7 Mode B2 3-b Mode F 3-4 Mode A3 3-8 Mode C	4.OUTPUT TIME 4-1 Hold 4-5 5S 4-2 0.1S 4-6 10S 4-3 0.5S 4-7 15S 4-4 1S 4-8 20S
5.INPUT SIGNAL TIME 5-1 20 mS 5-2 1 mS	6.KEY PROTECTION LEVEL* 6-1 Lock function key FUN 6-2 Lock reset key RST 6-3 Lock preset value key ▲▼↔ 6-4 Lock all key	7.OUTPUT CONTACT 7-1 2C 7-2 1A1C	9.FUNCTION MODE 9-1 Counter 9-2 Timer
*Note: 1.In NPN INPUT MODE, PIN 13 should be connect with PIN 8. 2.In PNP INPUT MODE, PIN 13 should be connect with PIN 12.			

TIMING CHART(COUNTER)

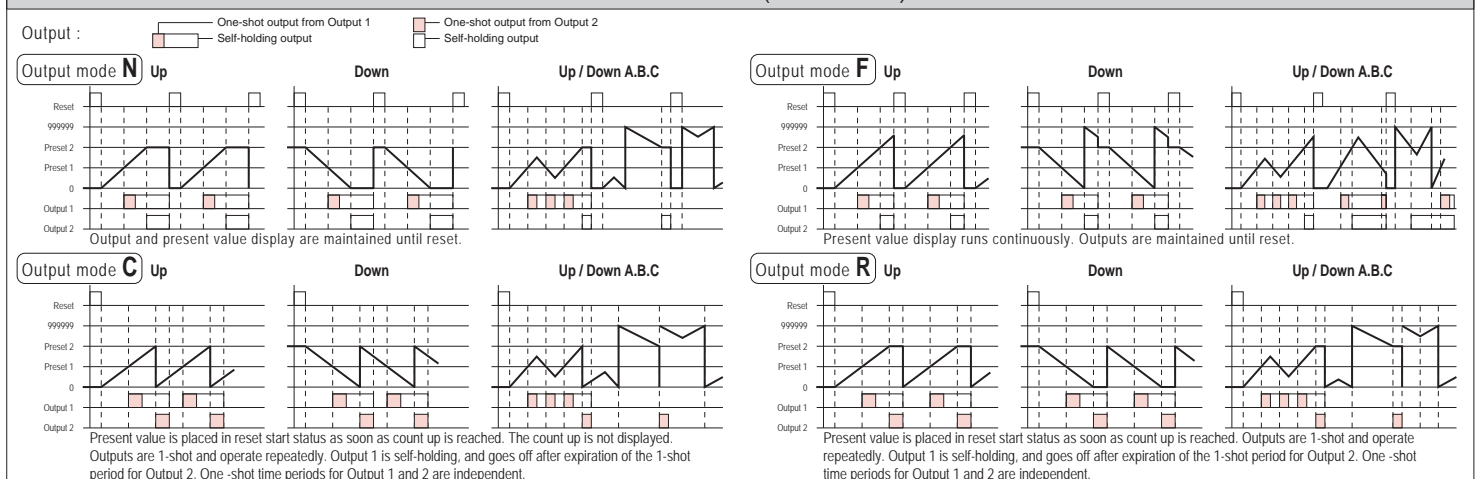

Output mode **K** Up

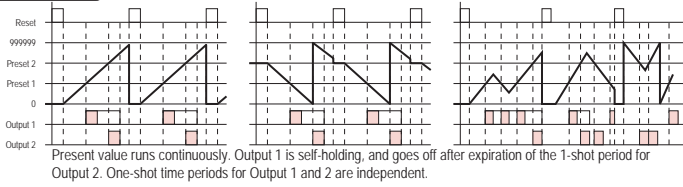

Output mode **P** Up

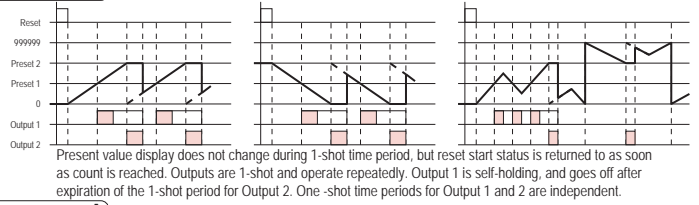

Output mode **Q** Up

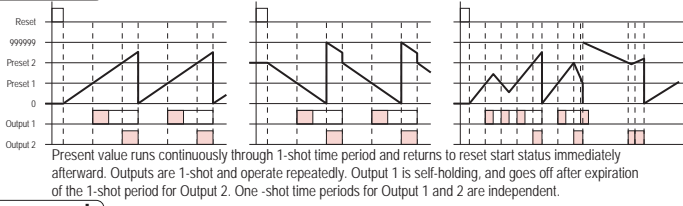

Output mode **A** Up

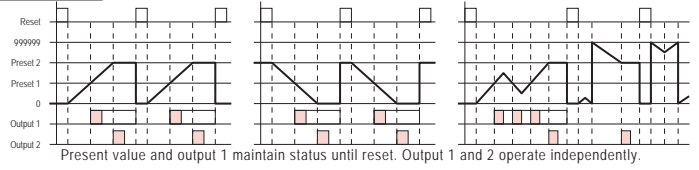

Output mode **L** Up

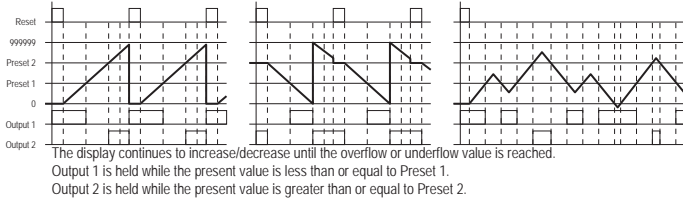

Output mode **H** Up

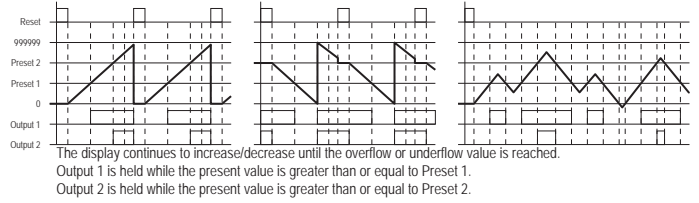

TIMING CHART (TIMER)

A: Signal ON delay 1

(Timer resets when power comes ON.)

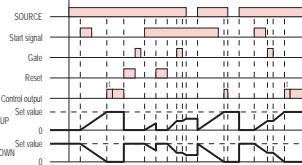

Timing starts when the start signal goes ON. *Note1
The control output is controlled using a sustained or one-shot time period.

A-1: Signal ON delay 2

(Timer resets when power comes ON.)

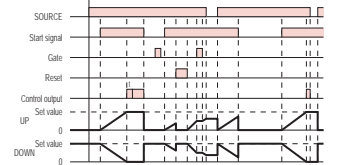

Timing starts when the start signal goes ON, and is reset when the start signal goes OFF. *Note1
The control output is controlled using a sustained or one-shot time period.

A-2: Power ON delay 1

(Timer resets when power comes ON.)

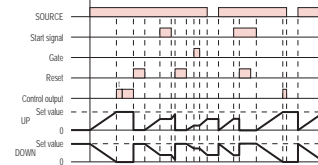

Timing starts when the reset input goes OFF. The start signal disables the timing function (i.e., same function as the gate input). The control output is controlled using a sustained or one-shot time period.

A-3: Power ON delay 2

(Timer does not reset when power comes ON.)

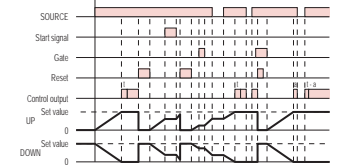

Timing starts when the reset input goes OFF. The start signal disables the timing function (i.e., same function as the gate input). The control output is controlled using a sustained or one-shot time period.

B: Repeat cycle 1

(Timer resets when power comes ON.)

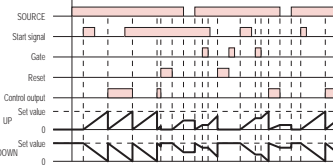

Timing starts when the start signal goes ON. *Note1
The status of the control output is reversed when time is up (OFF at start).

B-1: Repeat cycle 2

(Timer does not reset when power comes ON.)

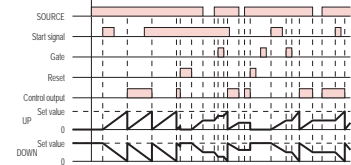

Timing starts when the start signal goes ON. *Note1
The status of the control output is reversed when time is up (OFF at start).

B-2: Repeat cycle ON start

(Timer resets when power comes ON.)

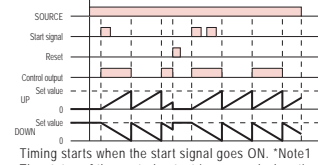

Timing starts when the start signal goes ON. *Note1
The status of the control output is reversed when time is up (OFF at start).

C: Signal ON/OFF delay

(Timer resets when power comes ON.)

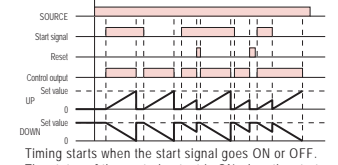

Timing starts when the start signal goes ON or OFF. The status of the control output is ON when the start signal goes ON or OFF.

D: Signal OFF delay

(Timer resets when power comes ON.)

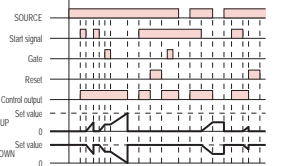

The control output is ON when the start signal is ON (except when the power is OFF or the reset is ON). The timer is reset when the time is up.

E: Interval

(Timer resets when power comes ON.)

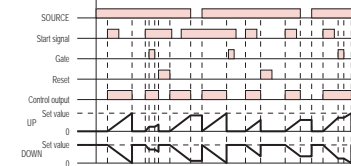

Timing starts when the start signal comes ON. *Note1
The control output is reset when time is up.

F: Cumulative

(Timer does not reset when power comes ON.)

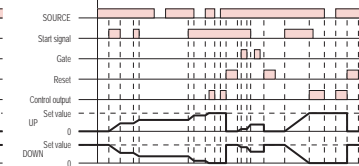

Start signal enables timing (timing is stopped when the start signal is OFF or when the power is OFF). A sustained control output is used.

*Note1. While the start signal is ON, the timer starts when power comes ON or when the reset input goes OFF.

CONNECTION

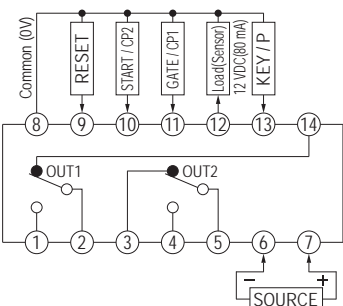

DIMENSION (mm)

