

SKM100GAL12T4



SEMITRANS® 2

Fast IGBT4 Modules

SKM100GAL12T4

Features

- IGBT4 = 4. generation fast trench IGBT (Infineon)
- CAL4 = Soft switching 4. generation CAL-diode
- Isolated copper baseplate using DBC technology (Direct Bonded Copper)
- Increased power cycling capability
- With integrated gate resistor
- For higher switching frequencies up to 20kHz
- UL recognized, file no. E63532

Typical Applications*

- Electronic welders at fsw up to 20 kHz
- DC/DC – converter
- Brake chopper
- Switched reluctance motor

Remarks

- Case temperature limited to $T_c = 125^\circ\text{C}$ max.
- Recommended $T_{op} = -40 \dots +150^\circ\text{C}$
- Product reliability results valid for $T_j = 150^\circ\text{C}$

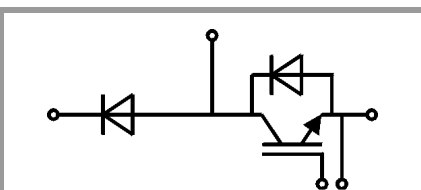

GAL

Absolute Maximum Ratings

Symbol	Conditions	Values	Unit	
IGBT				
V_{CES}	$T_j = 25^\circ\text{C}$	1200	V	
I_C	$T_j = 175^\circ\text{C}$	$T_c = 25^\circ\text{C}$	160	A
		$T_c = 80^\circ\text{C}$	123	A
I_{Cnom}		100	A	
I_{CRM}	$I_{CRM} = 3 \times I_{Cnom}$	300	A	
V_{GES}		-20 ... 20	V	
t_{psc}	$V_{CC} = 800\text{ V}$	10	μs	
	$V_{GE} \leq 15\text{ V}$			
	$V_{CES} \leq 1200\text{ V}$		$T_j = 150^\circ\text{C}$	
T_j		-40 ... 175	$^\circ\text{C}$	
Inverse diode				
I_F	$T_j = 175^\circ\text{C}$	$T_c = 25^\circ\text{C}$	121	A
		$T_c = 80^\circ\text{C}$	91	A
I_{Fnom}		100	A	
I_{FRM}	$I_{FRM} = 3 \times I_{Fnom}$	300	A	
I_{FSM}	$t_p = 10\text{ ms, sin } 180^\circ, T_j = 25^\circ\text{C}$	550	A	
T_j		-40 ... 175	$^\circ\text{C}$	
Freewheeling diode				
I_F	$T_j = 175^\circ\text{C}$	$T_c = 25^\circ\text{C}$	121	A
		$T_c = 80^\circ\text{C}$	91	A
I_{Fnom}		100	A	
I_{FRM}	$I_{FRM} = 3 \times I_{Fnom}$	300	A	
I_{FSM}	$t_p = 10\text{ ms, sin } 180^\circ, T_j = 25^\circ\text{C}$	550	A	
T_j		-40 ... 175	$^\circ\text{C}$	
Module				
$I_{t(RMS)}$	$T_{terminal} = 80^\circ\text{C}$	200	A	
T_{stg}		-40 ... 125	$^\circ\text{C}$	
V_{isol}	AC sinus 50 Hz, $t = 1\text{ min}$	4000	V	

Characteristics

Symbol	Conditions	min.	typ.	max.	Unit
IGBT					
$V_{CE(sat)}$	$I_C = 100\text{ A}$ $V_{GE} = 15\text{ V}$ chipelevel	$T_j = 25^\circ\text{C}$	1.80	2.05	V
		$T_j = 150^\circ\text{C}$	2.20	2.40	V
V_{CE0}	chipelevel	$T_j = 25^\circ\text{C}$	0.8	0.9	V
		$T_j = 150^\circ\text{C}$	0.7	0.8	V
r_{CE}	$V_{GE} = 15\text{ V}$ chipelevel	$T_j = 25^\circ\text{C}$	10.00	11.50	m Ω
		$T_j = 150^\circ\text{C}$	15.00	16.00	m Ω
$V_{GE(th)}$	$V_{GE} = V_{CE}, I_C = 3.8\text{ mA}$	5	5.8	6.5	V
I_{CES}	$V_{GE} = 0\text{ V}$ $V_{CE} = 1200\text{ V}$	$T_j = 25^\circ\text{C}$		1	mA
		$T_j = 150^\circ\text{C}$			mA
C_{ies}	$V_{CE} = 25\text{ V}$		6.15		nF
C_{oes}	$V_{GE} = 0\text{ V}$		0.40		nF
C_{res}			0.345		nF
Q_G	$V_{GE} = -8\text{ V} \dots +15\text{ V}$		565		nC
R_{Gint}	$T_j = 25^\circ\text{C}$		7.5		Ω

SKM100GAL12T4



SEMITRANS® 2

Fast IGBT4 Modules

SKM100GAL12T4

Features

- IGBT4 = 4. generation fast trench IGBT (Infineon)
- CAL4 = Soft switching 4. generation CAL-diode
- Isolated copper baseplate using DBC technology (Direct Bonded Copper)
- Increased power cycling capability
- With integrated gate resistor
- For higher switching frequencies up to 20kHz
- UL recognized, file no. E63532

Typical Applications*

- Electronic welders at fsw up to 20 kHz
- DC/DC – converter
- Brake chopper
- Switched reluctance motor

Remarks

- Case temperature limited to $T_c = 125^\circ\text{C}$ max.
- Recommended $T_{op} = -40 \dots +150^\circ\text{C}$
- Product reliability results valid for $T_j = 150^\circ\text{C}$

Characteristics						
Symbol	Conditions		min.	typ.	max.	Unit
$t_{d(on)}$	$V_{CC} = 600\text{ V}$	$T_j = 150^\circ\text{C}$		165		ns
t_r	$I_C = 100\text{ A}$	$T_j = 150^\circ\text{C}$		47		ns
E_{on}	$V_{GE} = \pm 15\text{ V}$	$T_j = 150^\circ\text{C}$		15		mJ
$t_{d(off)}$	$R_{G\ on} = 1\ \Omega$	$T_j = 150^\circ\text{C}$		400		ns
t_f	$R_{G\ off} = 1\ \Omega$	$T_j = 150^\circ\text{C}$		75		ns
E_{off}	$di/dt_{on} = 1800\text{ A}/\mu\text{s}$	$T_j = 150^\circ\text{C}$		10.2		mJ
	$di/dt_{off} = 1130\text{ A}/\mu\text{s}$	$T_j = 150^\circ\text{C}$				
$R_{th(j-c)}$	per IGBT				0.27	K/W
Inverse diode						
$V_F = V_{EC}$	$I_F = 100\text{ A}$	$T_j = 25^\circ\text{C}$		2.20	2.52	V
	$V_{GE} = 0\text{ V}$	$T_j = 150^\circ\text{C}$		2.15	2.47	V
	chipelevel					
V_{F0}		$T_j = 25^\circ\text{C}$		1.3	1.5	V
	chipelevel	$T_j = 150^\circ\text{C}$		0.9	1.1	V
r_F		$T_j = 25^\circ\text{C}$		9.0	10.2	m Ω
	chipelevel	$T_j = 150^\circ\text{C}$		12.5	13.7	m Ω
I_{RRM}	$I_F = 100\text{ A}$	$T_j = 150^\circ\text{C}$		54		A
Q_{rr}	$di/dt_{off} = 1600\text{ A}/\mu\text{s}$	$T_j = 150^\circ\text{C}$		15.7		μC
E_{rr}	$V_{GE} = \pm 15\text{ V}$	$T_j = 150^\circ\text{C}$		5.9		mJ
	$V_{CC} = 600\text{ V}$	$T_j = 150^\circ\text{C}$				
$R_{th(j-c)}$	per diode				0.48	K/W
Freewheeling diode						
$V_F = V_{EC}$	$I_F = 100\text{ A}$	$T_j = 25^\circ\text{C}$		2.20	2.52	V
	$V_{GE} = 0\text{ V}$	$T_j = 150^\circ\text{C}$		2.15	2.47	V
	chipelevel					
V_{F0}		$T_j = 25^\circ\text{C}$		1.3	1.5	V
	chipelevel	$T_j = 150^\circ\text{C}$		0.9	1.1	V
r_F		$T_j = 25^\circ\text{C}$		9.0	10.2	m Ω
	chipelevel	$T_j = 150^\circ\text{C}$		12.5	13.7	m Ω
I_{RRM}	$I_F = 100\text{ A}$	$T_j = 150^\circ\text{C}$		54		A
Q_{rr}	$di/dt_{off} = 1600\text{ A}/\mu\text{s}$	$T_j = 150^\circ\text{C}$		15.7		μC
E_{rr}	$V_{GE} = \pm 15\text{ V}$	$T_j = 150^\circ\text{C}$		5.9		mJ
	$V_{CC} = 600\text{ V}$	$T_j = 150^\circ\text{C}$				
$R_{th(j-c)}$	per Diode				0.48	K/W
Module						
L_{CE}					30	nH
R_{CC+EE}	terminal-chip	$T_c = 25^\circ\text{C}$		0.65		m Ω
		$T_c = 125^\circ\text{C}$		1		m Ω
$R_{th(c-s)}$	per module			0.04	0.05	K/W
M_s	to heat sink M6			3	5	Nm
M_t		to terminals M5		2.5	5	Nm
						Nm
w					160	g

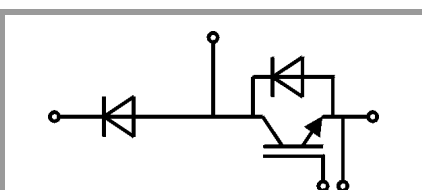

GAL

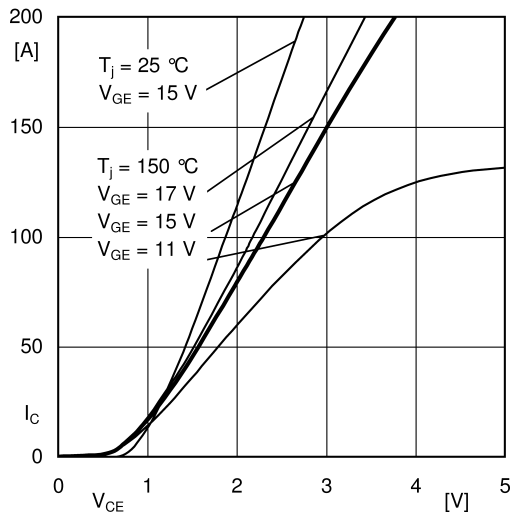

Fig. 1: Typ. output characteristic, inclusive $R_{CC+EE'}$

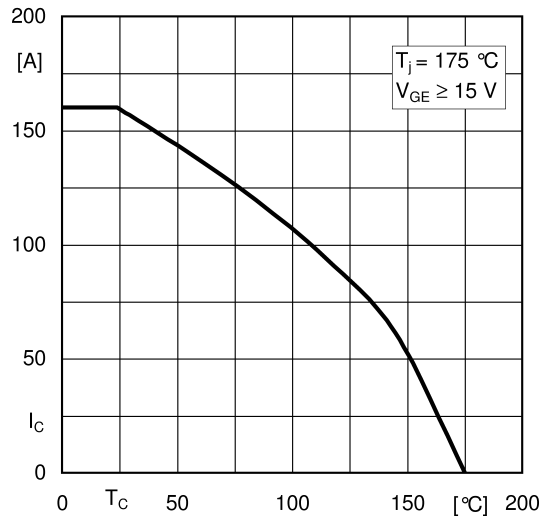

Fig. 2: Rated current vs. temperature $I_C = f(T_C)$

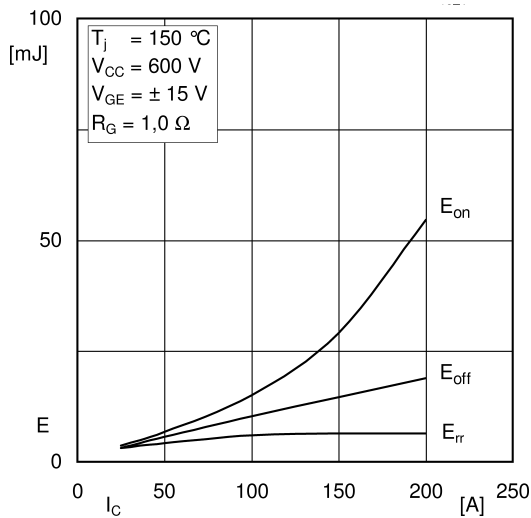

Fig. 3: Typ. turn-on /-off energy = $f(I_C)$

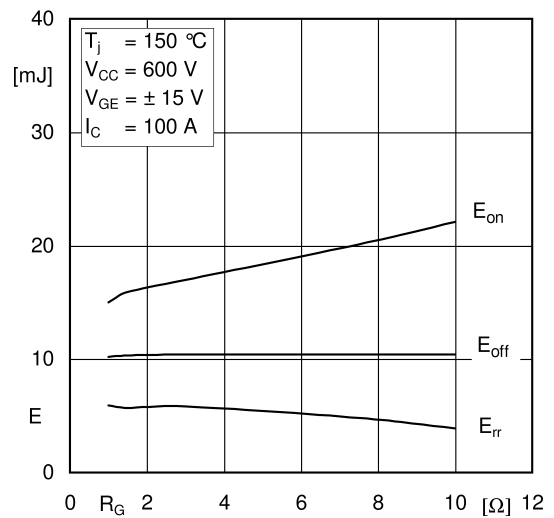

Fig. 4: Typ. turn-on /-off energy = $f(R_G)$

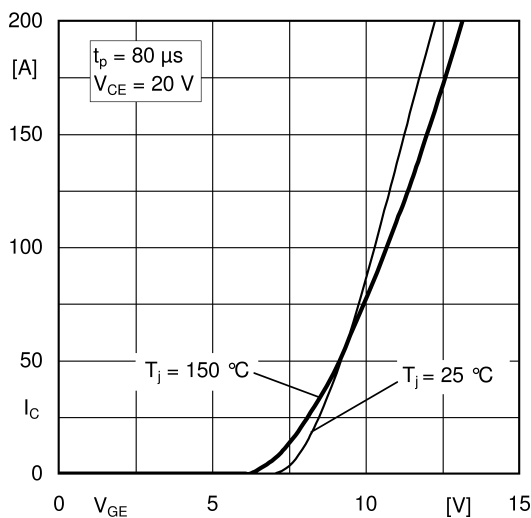

Fig. 5: Typ. transfer characteristic

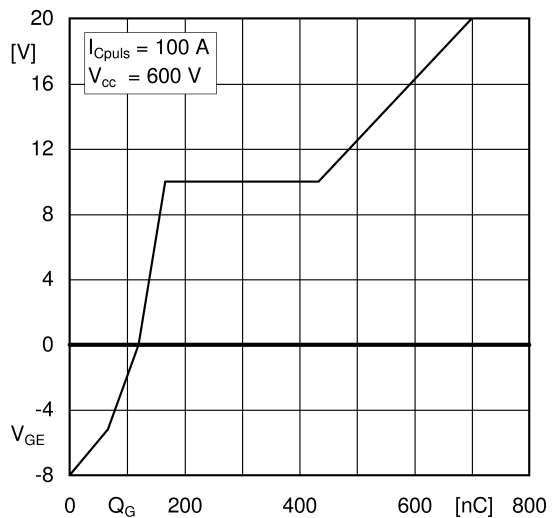

Fig. 6: Typ. gate charge characteristic

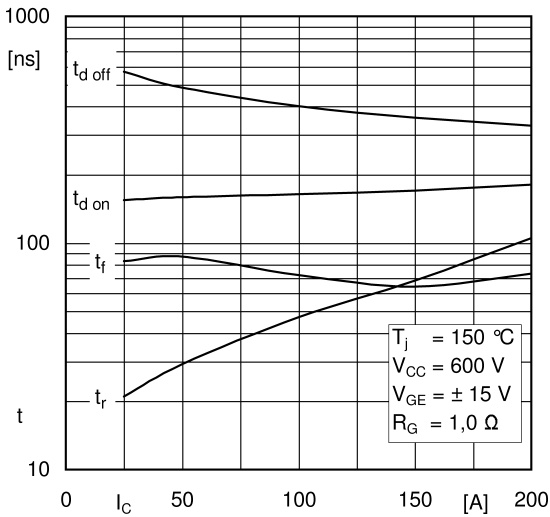

Fig. 7: Typ. switching times vs. I_C

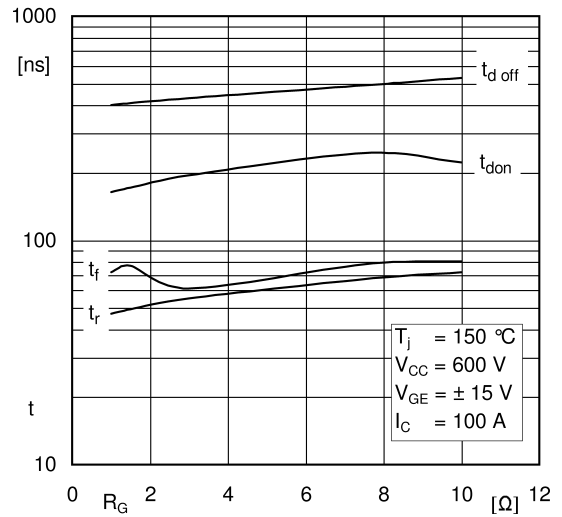

Fig. 8: Typ. switching times vs. gate resistor R_G

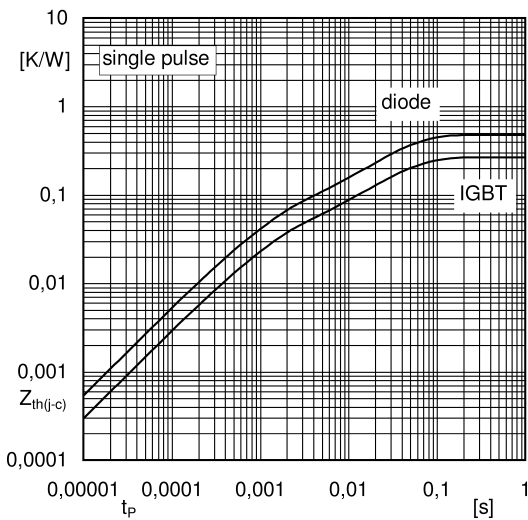

Fig. 9: Transient thermal impedance

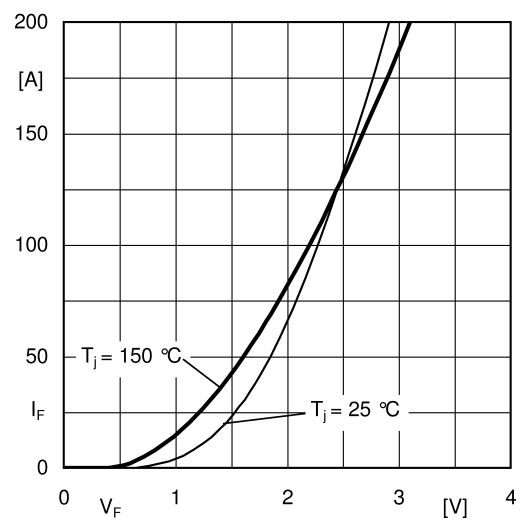

Fig. 10: Typ. CAL diode forward charact., incl. R_{CC+EE}

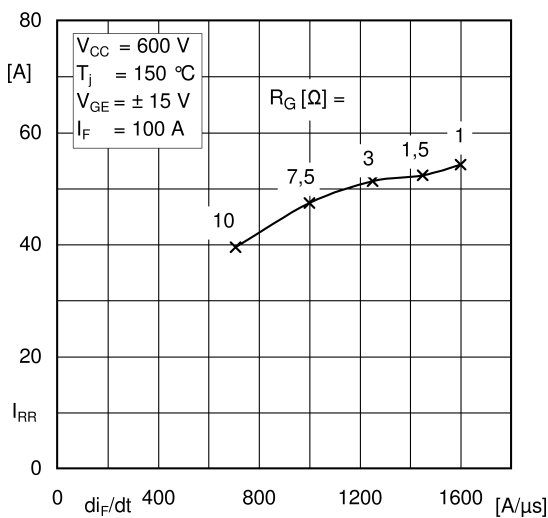

Fig. 11: CAL diode peak reverse recovery current

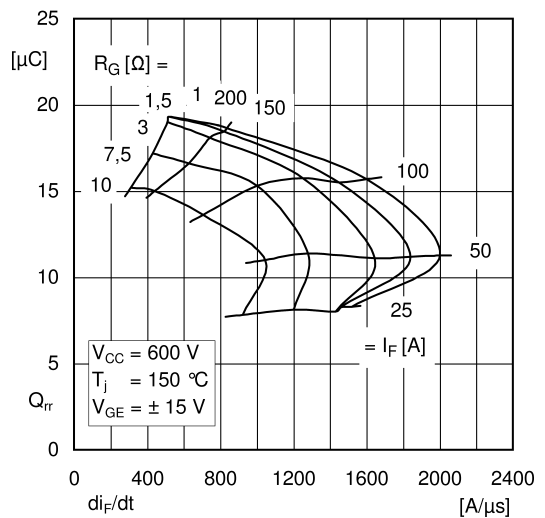
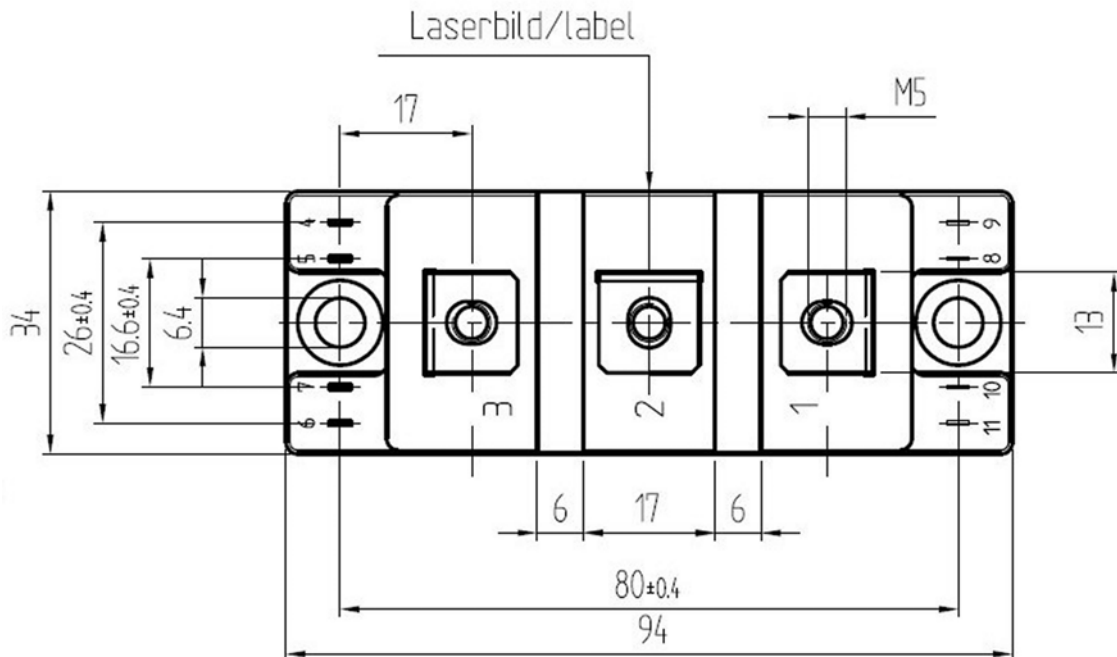
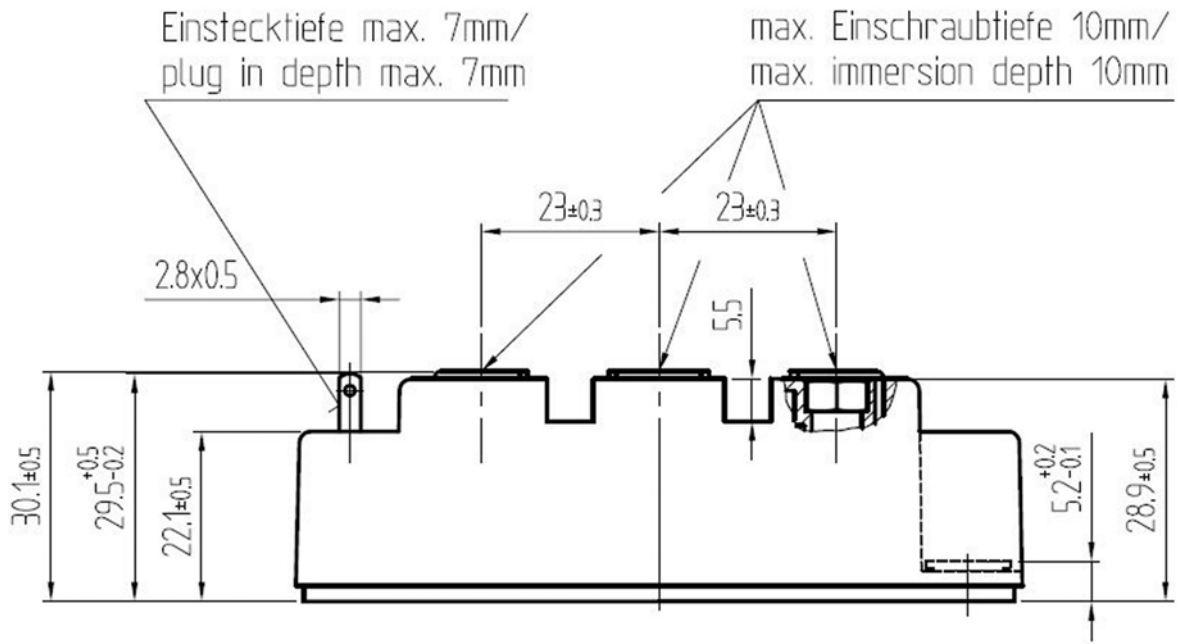
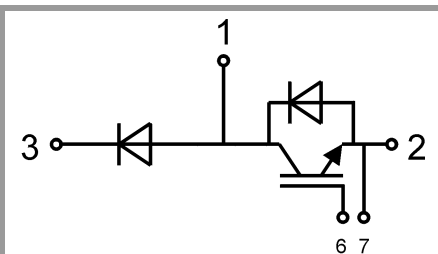

Fig. 12: Typ. CAL diode peak reverse recovery charge

SKM100GAL12T4



SEMITRANS 2



GAL

This is an electrostatic discharge sensitive device (ESDS), international standard IEC 60747-1, Chapter IX

* The specifications of our components may not be considered as an assurance of component characteristics. Components have to be tested for the respective application. Adjustments may be necessary. The use of SEMIKRON products in life support appliances and systems is subject to prior specification and written approval by SEMIKRON. We therefore strongly recommend prior consultation of our staff.