

# KA5x03xx-SERIES

KA5H0365R, KA5M0365R, KA5L0365R, KA5M0365RN,  
KA5L0365RN, KA5H0380R, KA5M0380R, KA5L0380R  
Fairchild Power Switch(FPS)

## Features

- Precision Fixed Operating Frequency (100/67/50kHz)
- Low Start-up Current(Typ. 100uA)
- Pulse by Pulse Current Limiting
- Over Current Protection
- Over Voltage Protection (Min. 25V)
- Internal Thermal Shutdown Function
- Under Voltage Lockout
- Internal High Voltage Sense FET
- Auto-Restart Mode

## Applications

- SMPS for VCR, SVR, STB, DVD & DVCD
- SMPS for Printer, Facsimile & Scanner
- Adaptor for Camcorder

## Description

The Fairchild Power Switch(FPS) product family is specially designed for an off-line SMPS with minimal external components. The Fairchild Power Switch(FPS) consists of a high voltage power SenseFET and a current mode PWM IC. Included PWM controller integrates the fixed frequency oscillator, the under voltage lock-out, the leading edge blanking, the optimized gate turn-on/turn-off driver, the thermal shutdown protection, the over voltage protection, and the temperature compensated precision current sources for the loop compensation and the fault protection circuitry. Compared to a discrete MOSFET and a PWM controller or an RCC solution, a Fairchild Power Switch(FPS) can reduce the total component count, design size and weight and at the same time increase efficiency, productivity, and system reliability. It has a basic platform well suited for the cost effective design in either a flyback converter or a forward converter

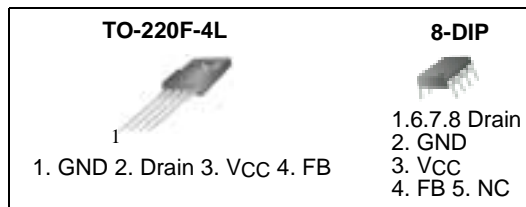

## Internal Block Diagram

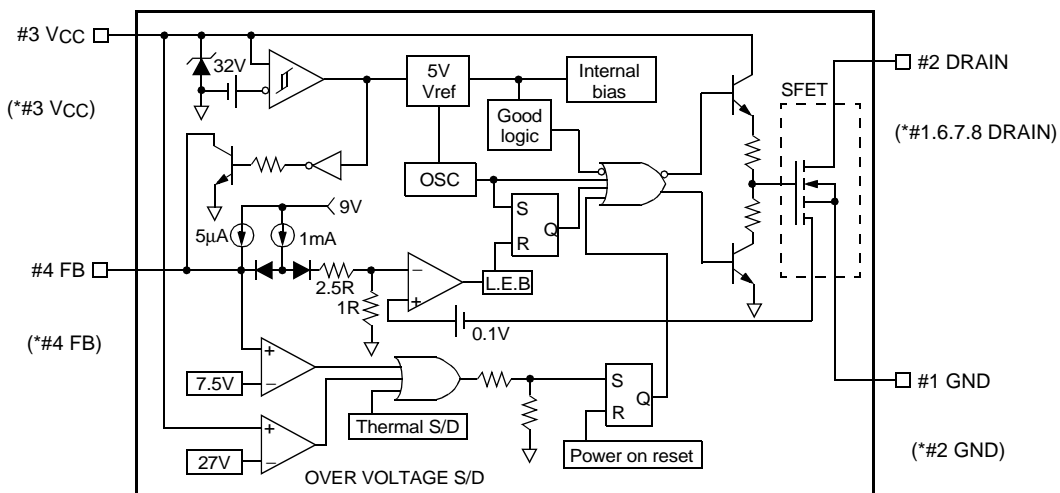

\*Asterisk - KA5M0365RN, KA5L0365RN

## Absolute Maximum Ratings

(Ta=25°C, unless otherwise specified)

Characteristic	Symbol	Value	Unit
<b>KA5H0365R, KA5M0365R, KA5L0365R</b>			
Maximum Drain Voltage	V <sub>D,MAX</sub>	650	V
Drain-Gate Voltage (R <sub>GS</sub> =1MΩ)	V <sub>DGR</sub>	650	V
Gate-Source (GND) Voltage	V <sub>GS</sub>	±30	V
Drain Current Pulsed <sup>(1)</sup>	I <sub>DM</sub>	12.0	ADC
Continuous Drain Current (T <sub>C</sub> =25°C)	I <sub>D</sub>	3.0	ADC
Continuous Drain Current (T <sub>C</sub> =100°C)	I <sub>D</sub>	2.4	ADC
Single Pulsed Avalanche Energy <sup>(2)</sup>	E <sub>AS</sub>	358	mJ
Maximum Supply Voltage	V <sub>CC,MAX</sub>	30	V
Analog Input Voltage Range	V <sub>FB</sub>	-0.3 to V <sub>SD</sub>	V
Total Power Dissipation	P <sub>D</sub>	75	W
	Derating	0.6	W/°C
Operating Junction Temperature.	T <sub>J</sub>	+160	°C
Operating Ambient Temperature.	T <sub>A</sub>	-25 to +85	°C
Storage Temperature Range.	T <sub>STG</sub>	-55 to +150	°C
<b>KA5H0380R, KA5M0380R, KA5L0380R</b>			
Maximum Drain Voltage	V <sub>D,MAX</sub>	800	V
Drain-Gate Voltage (R <sub>GS</sub> =1MΩ)	V <sub>DGR</sub>	800	V
Gate-Source (GND) Voltage	V <sub>GS</sub>	±30	V
Drain Current Pulsed <sup>(1)</sup>	I <sub>DM</sub>	12.0	ADC
Continuous Drain Current (T <sub>C</sub> =25°C)	I <sub>D</sub>	3.0	ADC
Continuous Drain Current (T <sub>C</sub> =100°C)	I <sub>D</sub>	2.1	ADC
Single Pulsed Avalanche Energy <sup>(2)</sup>	E <sub>AS</sub>	95	mJ
Maximum Supply Voltage	V <sub>CC,MAX</sub>	30	V
Analog Input Voltage Range	V <sub>FB</sub>	-0.3 to V <sub>SD</sub>	V
Total Power Dissipation	P <sub>D</sub>	75	W
	Derating	0.6	W/°C
Operating Junction Temperature.	T <sub>J</sub>	+160	°C
Operating Ambient Temperature.	T <sub>A</sub>	-25 to +85	°C
Storage Temperature Range.	T <sub>STG</sub>	-55 to +150	°C

**Note:**

1. Repetitive rating: Pulse width limited by maximum junction temperature
2. L = 51mH, starting T<sub>j</sub> = 25°C
3. L = 13μH, starting T<sub>j</sub> = 25°C

## Absolute Maximum Ratings

(Ta=25°C, unless otherwise specified)

Characteristic	Symbol	Value	Unit
<b>KA5M0365RN, KA5L0365RN</b>			
Maximum Drain Voltage	V <sub>D,MAX</sub>	650	V
Drain-Gate Voltage (R <sub>GS</sub> =1MΩ)	V <sub>DGR</sub>	650	V
Gate-Source (GND) Voltage	V <sub>GS</sub>	±30	V
Drain Current Pulsed <sup>(1)</sup>	I <sub>DM</sub>	12.0	ADC
Continuous Drain Current (Ta=25°C)	I <sub>D</sub>	0.42	ADC
Continuous Drain Current (Ta=100°C)	I <sub>D</sub>	0.28	ADC
Single Pulsed Avalanche Energy <sup>(2)</sup>	E <sub>AS</sub>	127	mJ
Maximum Supply Voltage	V <sub>CC,MAX</sub>	30	V
Analog Input Voltage Range	V <sub>FB</sub>	-0.3 to V <sub>SD</sub>	V
Total Power Dissipation	P <sub>D</sub>	1.56	W
	Derating	0.0125	W/°C
Operating Junction Temperature.	T <sub>J</sub>	+160	°C
Operating Ambient Temperature.	T <sub>A</sub>	-25 to +85	°C
Storage Temperature Range.	T <sub>STG</sub>	-55 to +150	°C

### Note:

1. Repetitive rating: Pulse width limited by maximum junction temperature
2. L = 51mH, starting T<sub>j</sub> = 25°C
3. L = 13μH, starting T<sub>j</sub> = 25°C

## Electrical Characteristics (SenseFET Part)

(Ta = 25°C unless otherwise specified)

Parameter	Symbol	Condition	Min.	Typ.	Max.	Unit
<b>KA5H0365R, KA5M0365R, KA5L0365R</b>						
Drain-Source Breakdown Voltage	BVDSS	VGS=0V, ID=50μA	650	-	-	V
Zero Gate Voltage Drain Current	IDSS	VDS=Max. Rating, VGS=0V	-	-	50	μA
		VDS=0.8Max. Rating, VGS=0V, TC=125°C	-	-	200	μA
Static Drain-Source on Resistance <sup>(Note)</sup>	RDS(ON)	VGS=10V, ID=0.5A	-	3.6	4.5	Ω
Forward Transconductance <sup>(Note)</sup>	gfs	VDS=50V, ID=0.5A	2.0	-	-	S
Input Capacitance	Ciss	VGS=0V, VDS=25V, f=1MHz	-	720	-	pF
Output Capacitance	Coss		-	40	-	
Reverse Transfer Capacitance	Crss		-	40	-	
Turn On Delay Time	td(on)	VDD=0.5BVDSS, ID=1.0A (MOSFET switching time is essentially independent of operating temperature)	-	150	-	nS
Rise Time	tr		-	100	-	
Turn Off Delay Time	td(off)		-	150	-	
Fall Time	tf		-	42	-	
Total Gate Charge (Gate-Source+Gate-Drain)	Qg	VGS=10V, ID=1.0A, VDS=0.5BVDSS (MOSFET switching time is essentially independent of operating temperature)	-	-	34	nC
Gate-Source Charge	Qgs		-	7.3	-	
Gate-Drain (Miller) Charge	Qgd		-	13.3	-	
<b>KA5H0380R, KA5M0380R, KA5L0380R</b>						
Drain-Source Breakdown Voltage	BVDSS	VGS=0V, ID=50μA	800	-	-	V
Zero Gate Voltage Drain Current	IDSS	VDS=Max. Rating, VGS=0V	-	-	250	μA
		VDS=0.8Max. Rating, VGS=0V, TC=125°C	-	-	1000	μA
Static Drain-Source on Resistance <sup>(Note)</sup>	RDS(ON)	VGS=10V, ID=0.5A	-	4.0	5.0	Ω
Forward Transconductance <sup>(Note)</sup>	gfs	VDS=50V, ID=0.5A	1.5	2.5	-	S
Input Capacitance	Ciss	VGS=0V, VDS=25V, f=1MHz	-	779	-	pF
Output Capacitance	Coss		-	75.6	-	
Reverse Transfer Capacitance	Crss		-	24.9	-	
Turn On Delay Time	td(on)	VDD=0.5BVDSS, ID=1.0A (MOSFET switching time is essentially independent of operating temperature)	-	40	-	nS
Rise Time	tr		-	95	-	
Turn Off Delay Time	td(off)		-	150	-	
Fall Time	tf		-	60	-	
Total Gate Charge (Gate-Source+Gate-Drain)	Qg	VGS=10V, ID=1.0A, VDS=0.5BVDSS (MOSFET switching time is essentially independent of operating temperature)	-	-	34	nC
Gate-Source Charge	Qgs		-	7.2	-	
Gate-Drain (Miller) Charge	Qgd		-	12.1	-	

**Note:**

1. Pulse test: Pulse width ≤ 300μS, duty ≤ 2%

2.  $S = \frac{1}{R}$

## Electrical Characteristics (SenseFET Part)

(Ta = 25°C unless otherwise specified)

Parameter	Symbol	Condition	Min.	Typ.	Max.	Unit
<b>KA5M0365RN, KA5L0365RN</b>						
Drain-Source Breakdown Voltage	BVDSS	VGS=0V, ID=50μA	650	-	-	V
Zero Gate Voltage Drain Current	IDSS	VDS=Max. Rating, VGS=0V	-	-	50	μA
		VDS=0.8Max. Rating, VGS=0V, TC=125°C	-	-	200	μA
Static Drain-Source on Resistance <sup>(Note)</sup>	RDS(ON)	VGS=10V, ID=0.5A	-	3.6	4.5	Ω
Forward Transconductance <sup>(Note)</sup>	gfs	VDS=50V, ID=0.5A	2.0	-	-	S
Input Capacitance	Ciss	VGS=0V, VDS=25V, f=1MHz	-	314.9	-	pF
Output Capacitance	Coss		-	47	-	
Reverse Transfer Capacitance	Crss		-	9	-	
Turn On Delay Time	td(on)	VDD=0.5BVDSS, ID=1.0A (MOSFET switching time is essentially independent of operating temperature)	-	11.2	-	nS
Rise Time	tr		-	34	-	
Turn Off Delay Time	td(off)		-	28.2	-	
Fall Time	tf		-	32	-	
Total Gate Charge (Gate-Source+Gate-Drain)	Qg	VGS=10V, ID=1.0A, VDS=0.5BVDSS (MOSFET switching time is essentially independent of operating temperature)			11.93	nC
Gate-Source Charge	Qgs		-	1.95	-	
Gate-Drain (Miller) Charge	Qgd			6.85		

**Note:**

1. Pulse test: Pulse width ≤ 300μS, duty ≤ 2%

2.  $S = \frac{1}{R}$

**Electrical Characteristics (Control Part)** (Continued)

(Ta = 25°C unless otherwise specified)

Characteristic	Symbol	Test condition	Min.	Typ.	Max.	Unit
<b>UVLO SECTION</b>						
Start Threshold Voltage	VSTART	VFB=GND	14	15	16	V
Stop Threshold Voltage	VSTOP	VFB=GND	8.4	9	9.6	V
<b>OSCILLATOR SECTION</b>						
Initial Accuracy	FOSC	KA5H0365R KA5H0380R	90	100	110	kHz
Initial Accuracy	FOSC	KA5M0365R KA5M0365RN KA5M0380R	61	67	73	kHz
Initial Accuracy	FOSC	KA5L0365R KA5L0365RN KA5L0380R	45	50	55	kHz
Frequency Change With Temperature <sup>(2)</sup>	-	-25°C≤Ta≤+85°C	-	±5	±10	%
Maximum Duty Cycle	Dmax	KA5H0365R KA5H0380R	62	67	72	%
Maximum Duty Cycle	Dmax	KA5M0365R KA5M0365RN KA5M0380R KA5L0365R KA5L0365RN KA5L0380R	72	77	82	%
<b>FEEDBACK SECTION</b>						
Feedback Source Current	IFB	Ta=25°C, 0V≤Vfb≤3V	0.7	0.9	1.1	mA
Shutdown Feedback Voltage	VSD	Vfb≥6.5V	6.9	7.5	8.1	V
Shutdown Delay Current	Idelay	Ta=25°C, 5V≤Vfb≤VSD	4	5	6	μA
<b>REFERENCE SECTION</b>						
Output Voltage <sup>(1)</sup>	Vref	Ta=25°C	4.80	5.00	5.20	V
Temperature Stability <sup>(1)(2)</sup>	Vref/ΔT	-25°C≤Ta≤+85°C	-	0.3	0.6	mV/°C
<b>CURRENT LIMIT(SELF-PROTECTION)SECTION</b>						
Peak Current Limit	I <sub>OVER</sub>	Max. inductor current	1.89	2.15	2.41	A
<b>PROTECTION SECTION</b>						
Over Voltage Protection	VOVP	VCC≥24V	25	27	29	V
Thermal Shutdown Temperature (Tj) <sup>(1)</sup>	TSD	-	140	160	-	°C
<b>TOTAL STANDBY CURRENT SECTION</b>						
Start-up Current	I <sub>START</sub>	VCC=14V	-	100	170	μA
Operating Supply Current (Control Part Only)	I <sub>OP</sub>	VCC≤28	-	7	12	mA

**Note:**

1. These parameters, although guaranteed, are not 100% tested in production
2. These parameters, although guaranteed, are tested in EDS(water test) process

# Typical Performance Characteristics(SenseFET part)

(KA5H0365R, KA5M0365R, KA5L0365R)

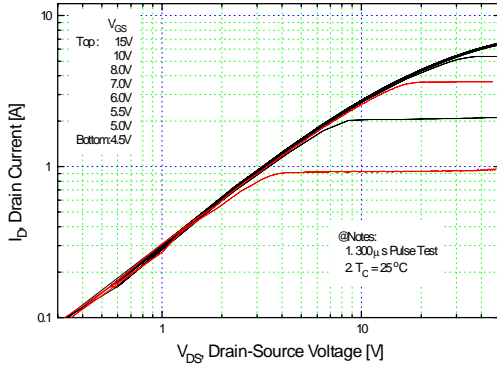

Figure 1. Output Characteristics

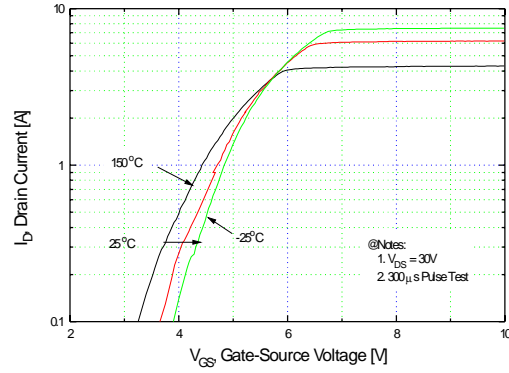

Figure 2. Transfer Characteristics

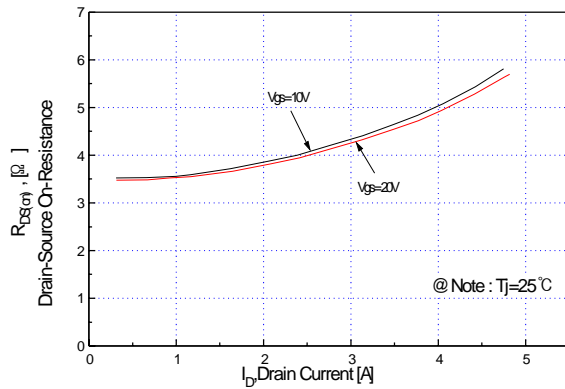

Figure 3. On-Resistance vs. Drain Current

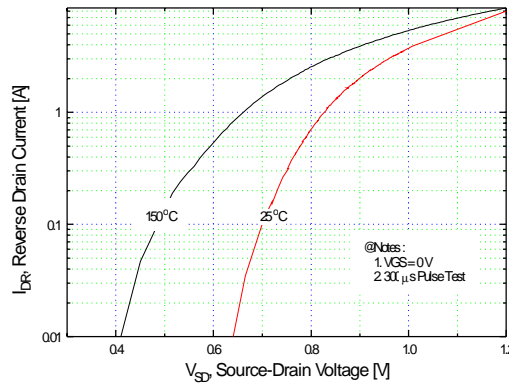

Figure 4. Source-Drain Diode Forward Voltage

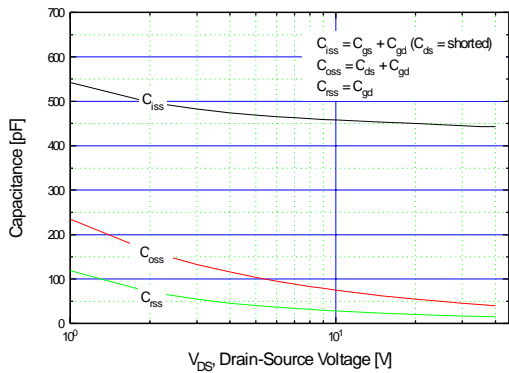

Figure 5. Capacitance vs. Drain-Source Voltage

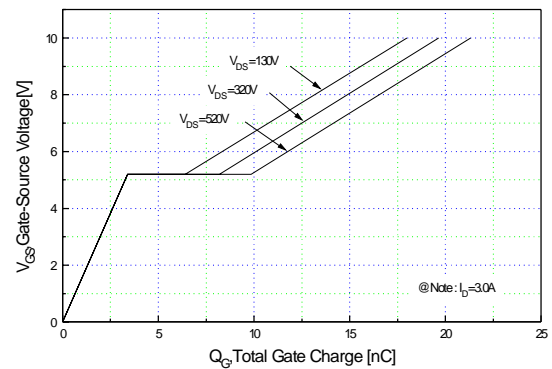

Figure 6. Gate Charge vs. Gate-Source Voltage

## Typical Performance Characteristics (Continued)

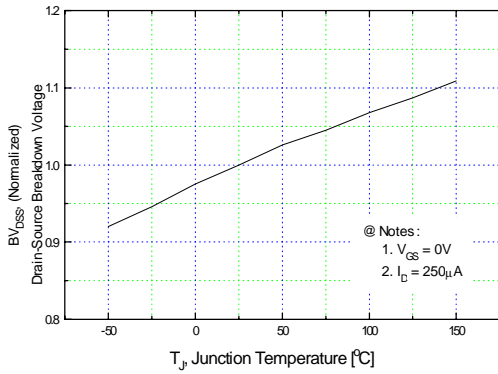

Figure 7. Breakdown Voltage vs. Temperature

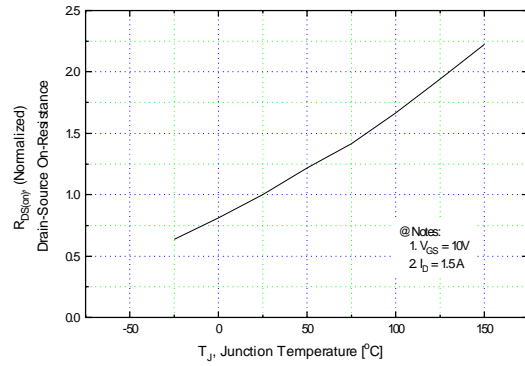

Figure 8. On-Resistance vs. Temperature

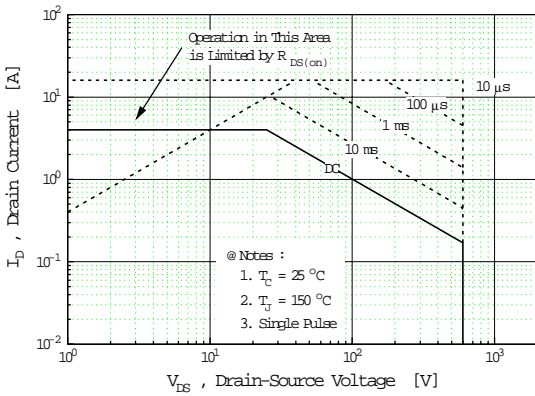

Figure 9. Max. Safe Operating Area

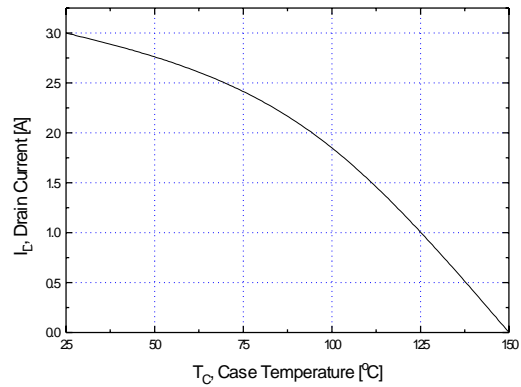

Figure 10. Max. Drain Current vs. Case Temperature

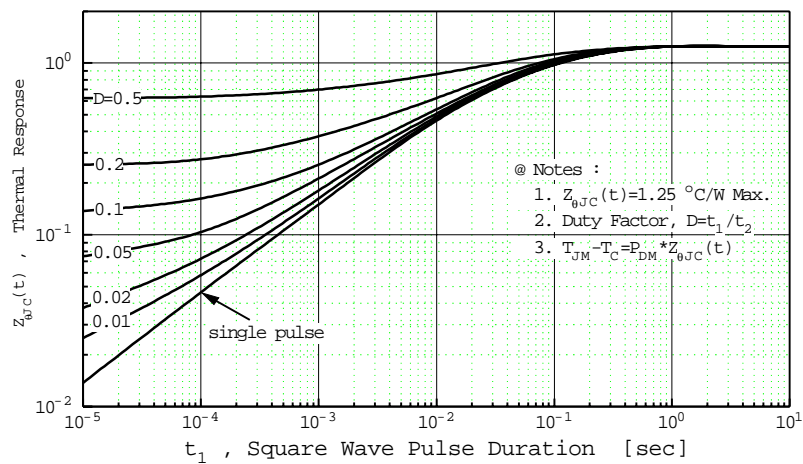

Figure 11. Thermal Response



# Typical Performance Characteristics (Continued)

(KA5H0380R, KA5M0380R, KA5L0380R)

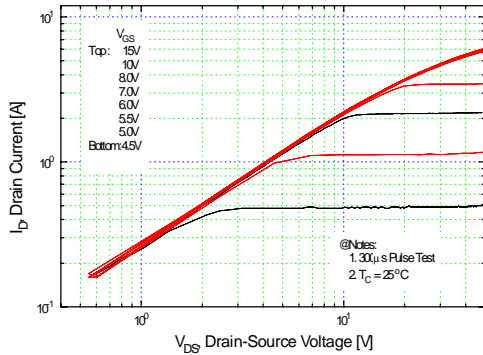

Figure 1. Output Characteristics

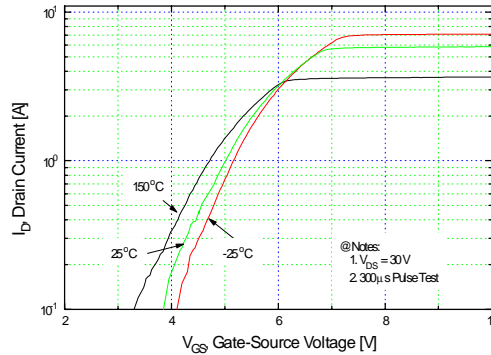

Figure 2. Transfer Characteristics

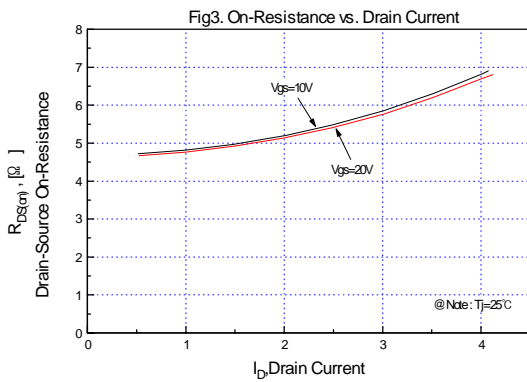

Figure 3. On-Resistance vs. Drain Current

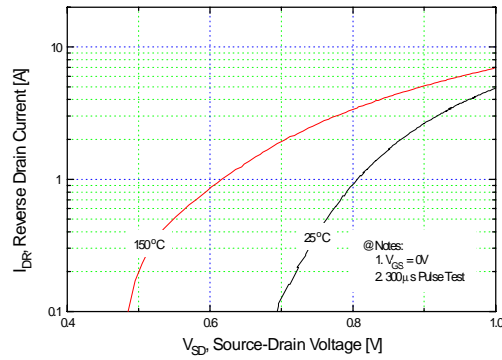

Figure 4. Source-Drain Diode Forward Voltage

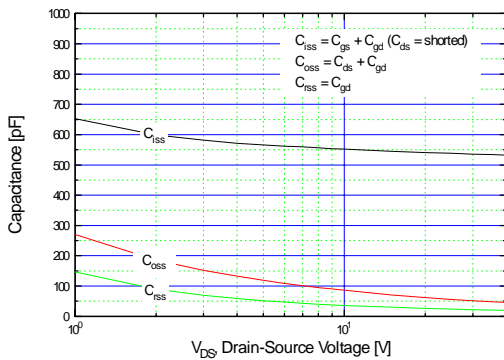

Figure 5. Capacitance vs. Drain-Source Voltage

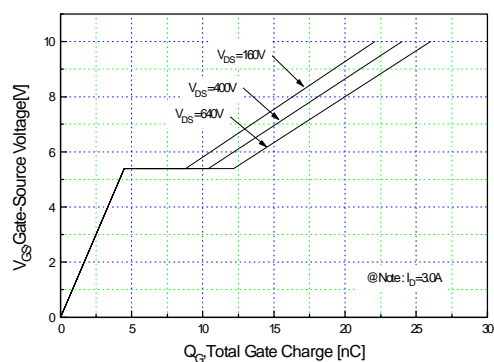

Figure 6. Gate Charge vs. Gate-Source Voltage

# Typical Performance Characteristics (Continued)

(KA5H0380R, KA5M0380R, KA5L0380R)

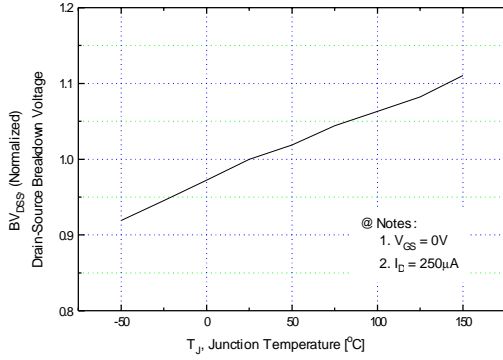

Figure 7. Breakdown Voltage vs. Temperature

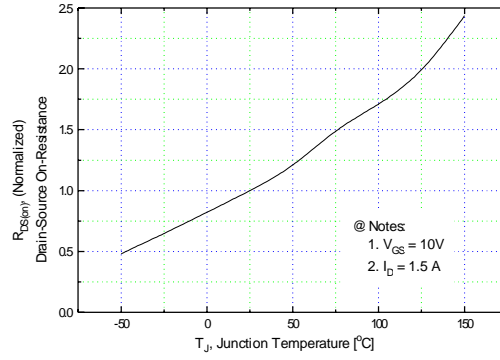

Figure 8. On-Resistance vs. Temperature

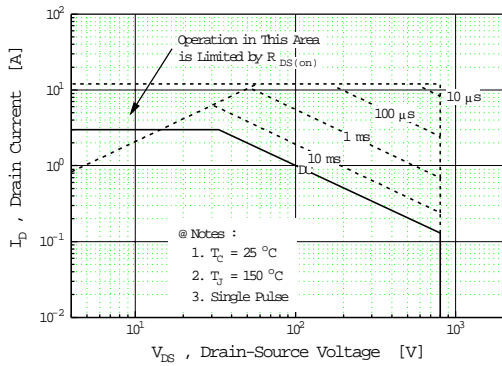

Figure 9. Max. Safe Operating Area

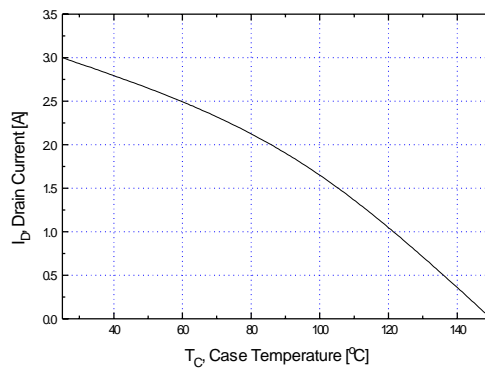

Figure 10. Max. Drain Current vs. Case Temperature

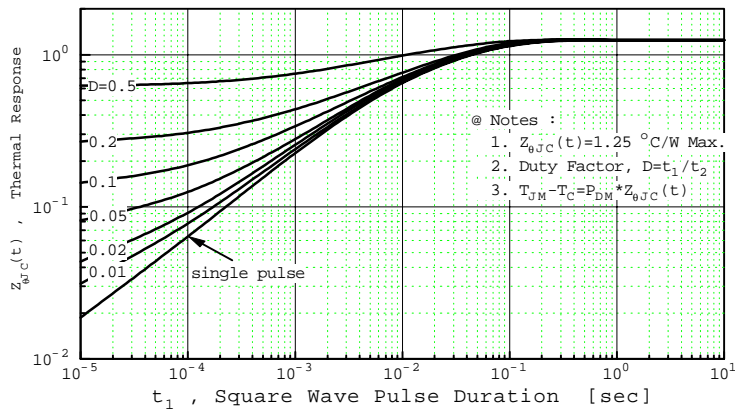

Figure 11. Thermal Response

# Typical Performance Characteristics(SenseFET part) (Continued)

(KA5M0365RN, KA5L0365RN)

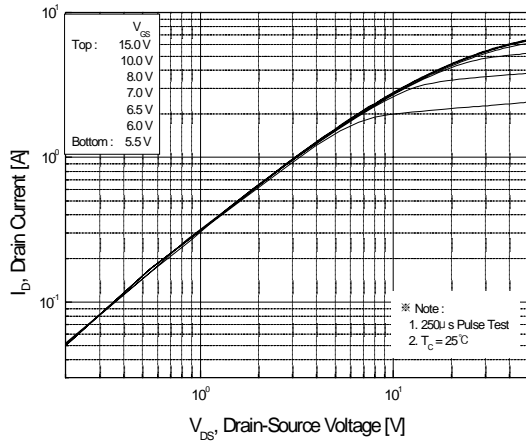

Figure 1. Output Characteristics

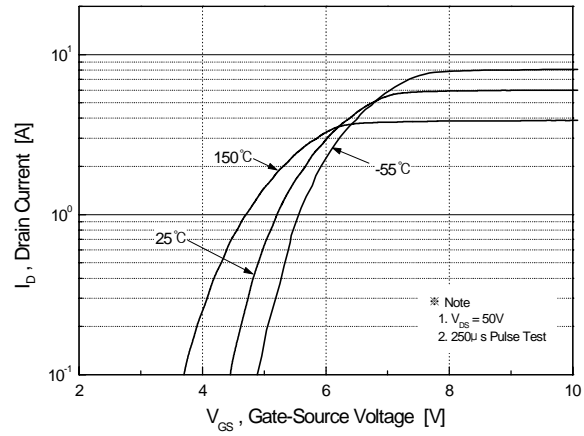

Figure 2. Transfer Characteristics

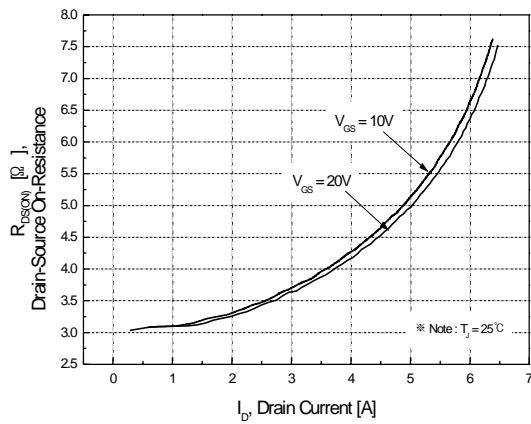

Figure 3. On-Resistance vs. Drain Current

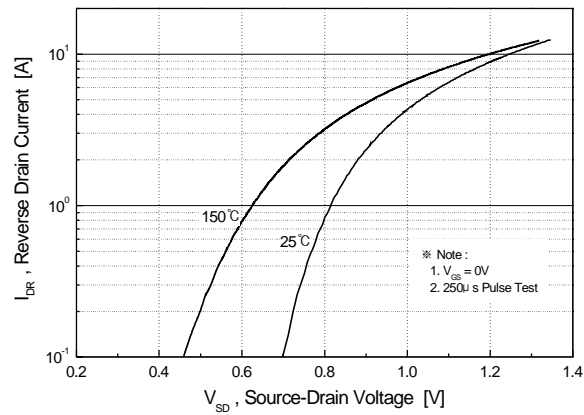

Figure 4. Source-Drain Diode Forward Voltage

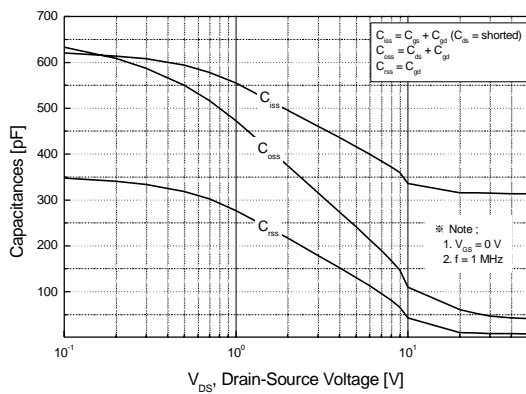

Figure 5. Capacitance vs. Drain-Source Voltage

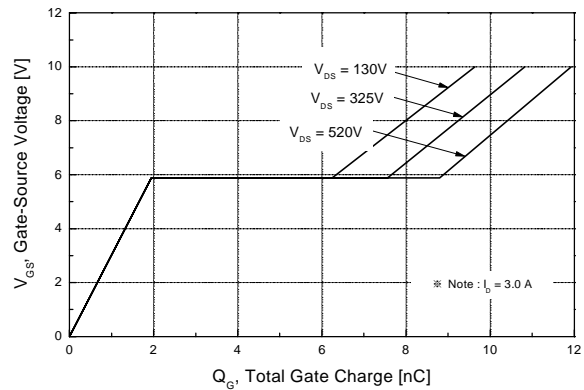

Figure 6. Gate Charge vs. Gate-Source Voltage

# Typical Performance Characteristics (Continued)

( KA5M0365RN, KA5L0365RN)

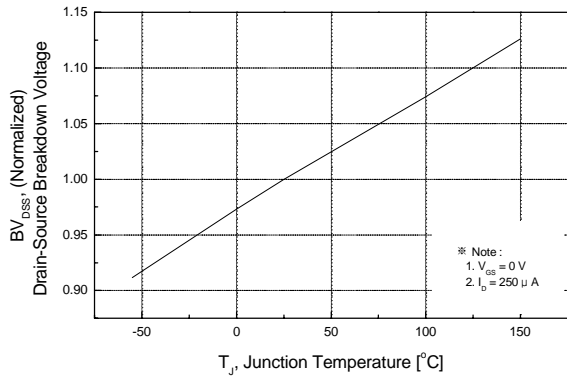

Figure 7. Breakdown Voltage vs. Temperature

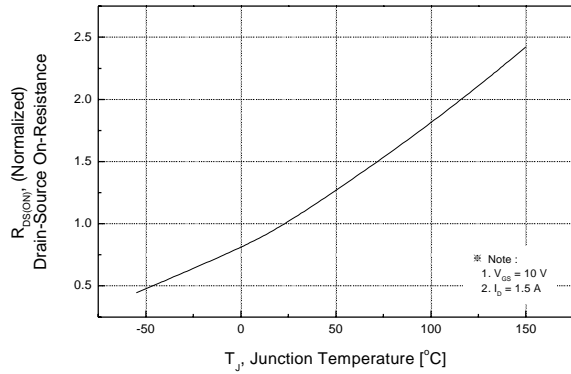

Figure 8. On-Resistance vs. Temperature

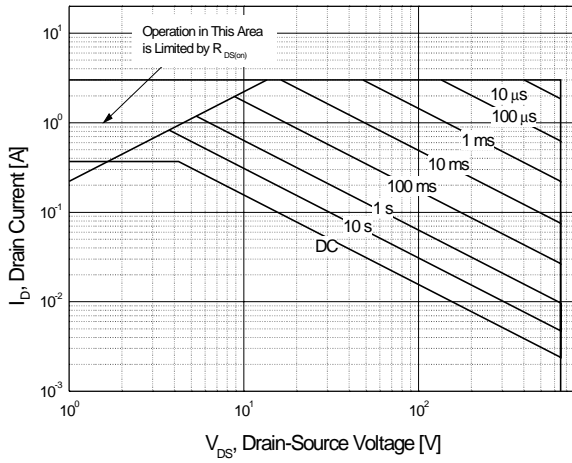

Figure 9. Max. Safe Operating Area

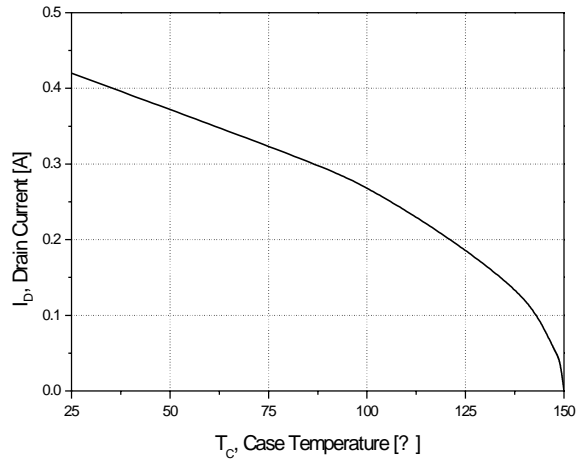

Figure 10. Max. Drain Current vs. Case Temperature

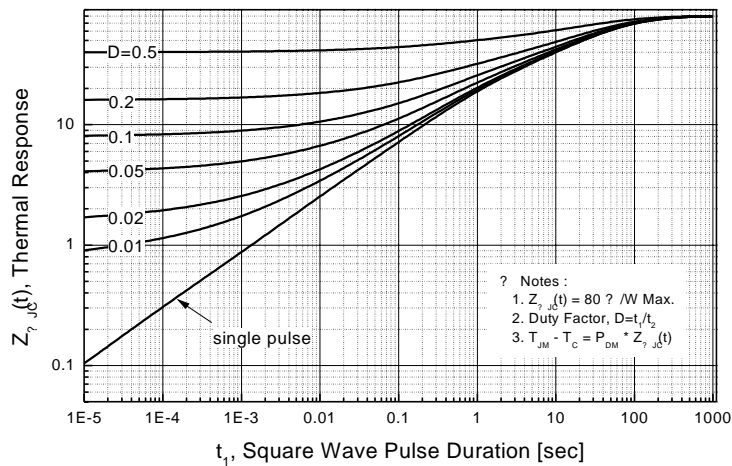

Figure 11. Thermal Response

## Typical Performance Characteristics (Control Part) (Continued)

(These characteristic graphs are normalized at  $T_a = 25^\circ\text{C}$ )

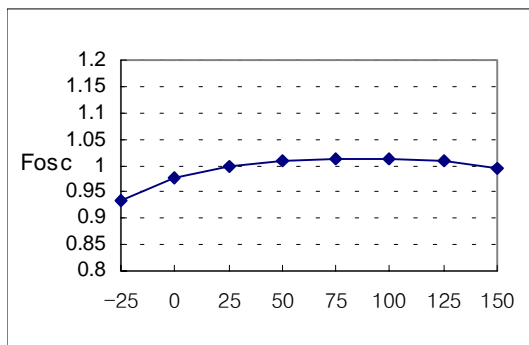

Figure 1. Operating Frequency

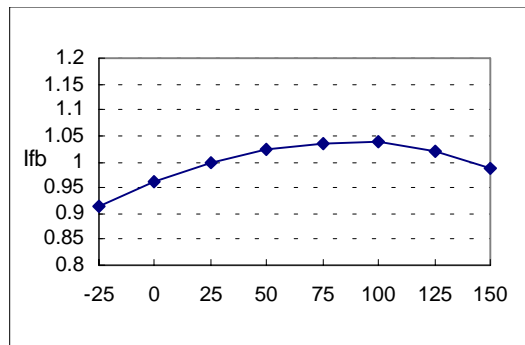

Figure 2. Feedback Source Current

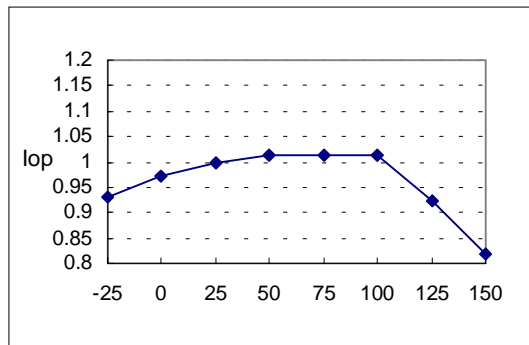

Figure 3. Operating Supply Current

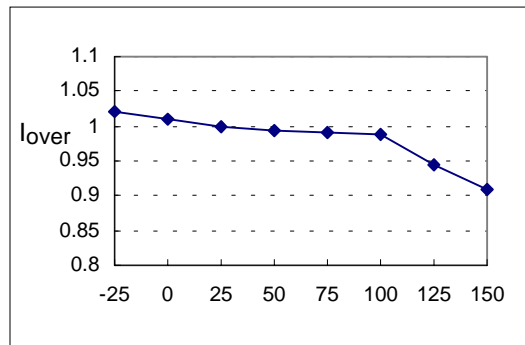

Figure 4. Peak Current Limit

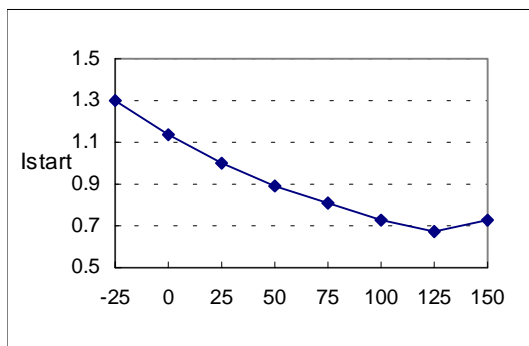

Figure 5. Start up Current

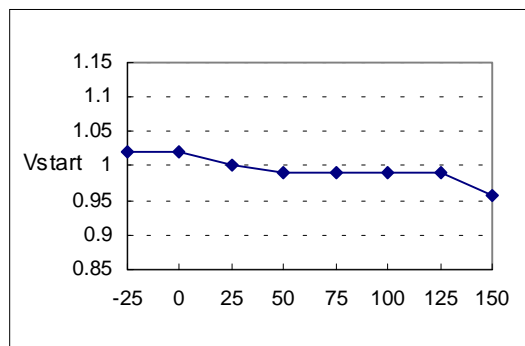

Figure 6. Start Threshold Voltage

## Typical Performance Characteristics (Continued)

(These characteristic graphs are normalized at  $T_a = 25^\circ\text{C}$ )

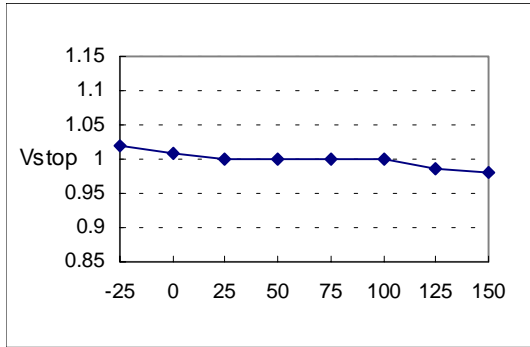

Figure 7. Stop Threshold Voltage

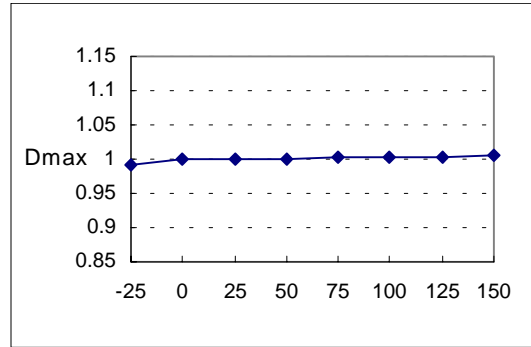

Figure 8. Maximum Duty Cycle

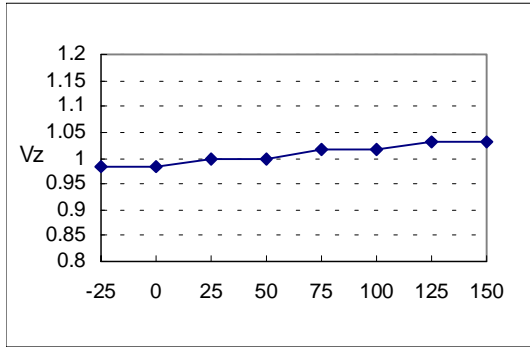

Figure 9. VCC Zener Voltage

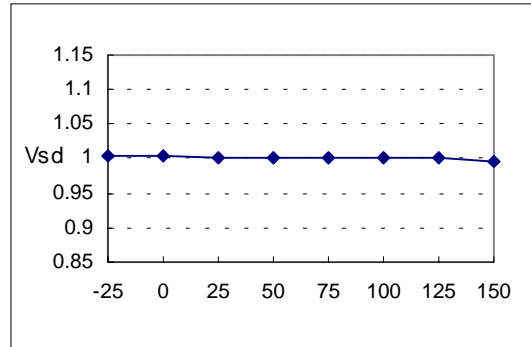

Figure 10. Shutdown Feedback Voltage

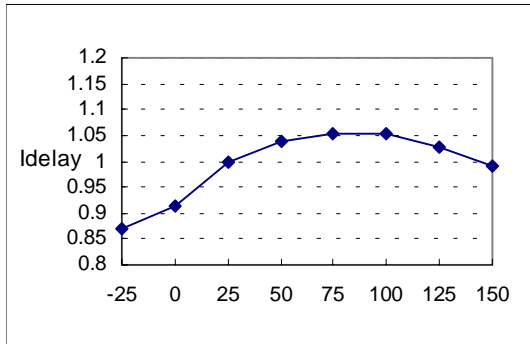

Figure 11. Shutdown Delay Current

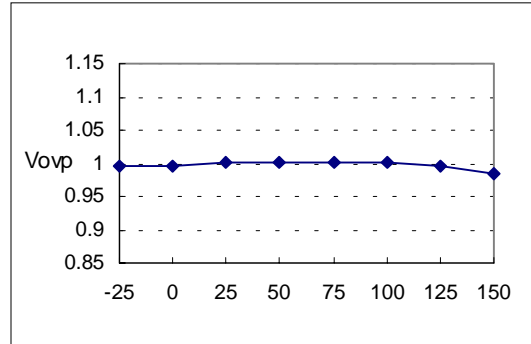

Figure 12. Over Voltage Protection

## Typical Performance Characteristics (Continued)

(These characteristic graphs are normalized at  $T_a = 25^\circ\text{C}$ )

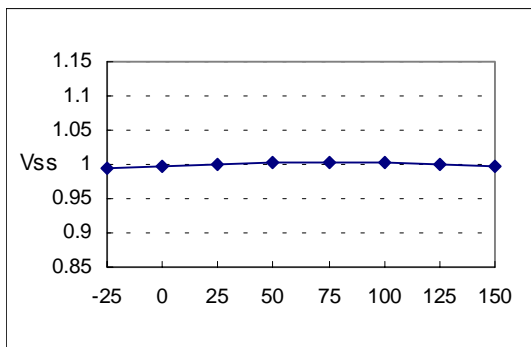

Figure13. Soft Start Voltage

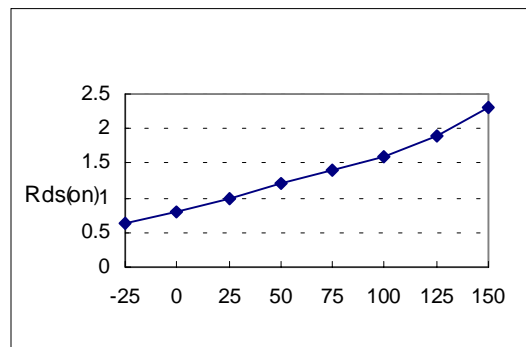
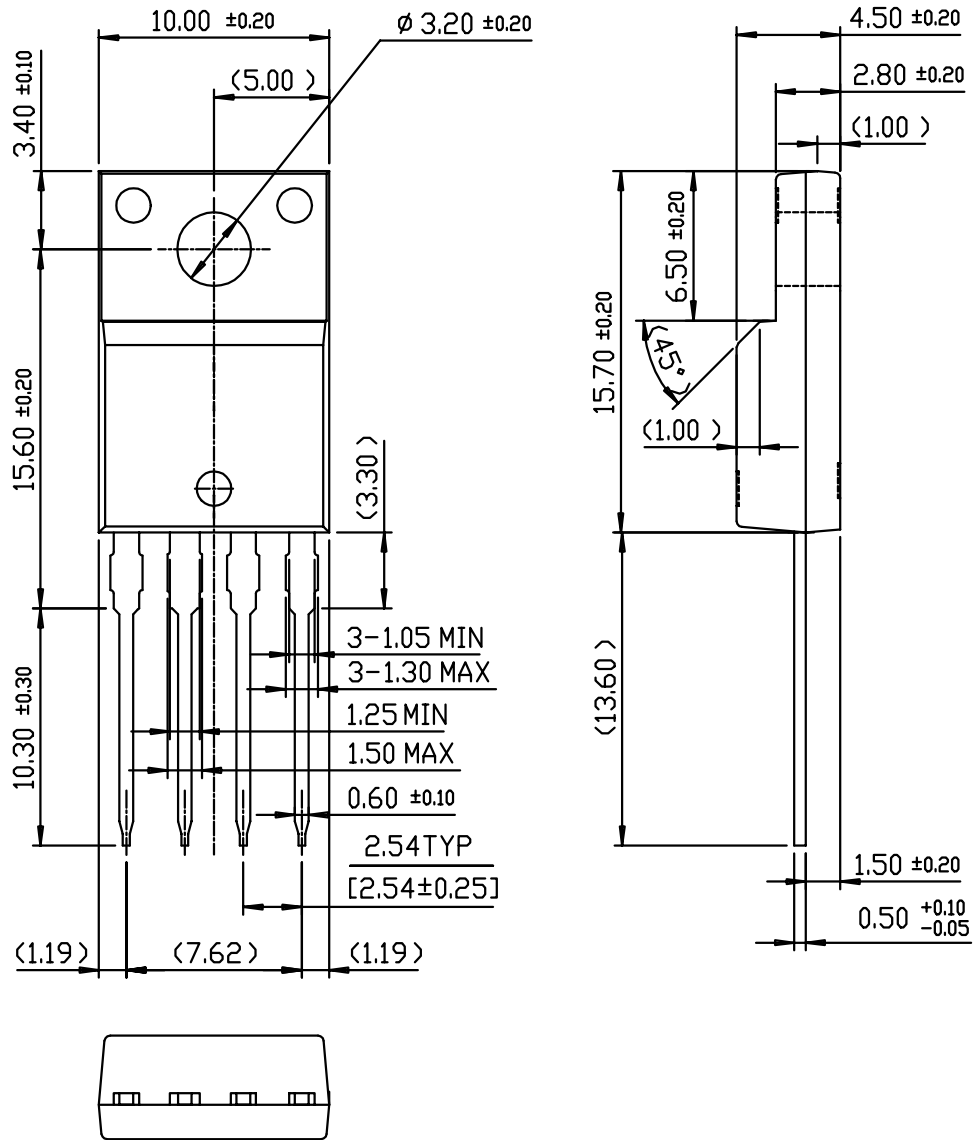

Figure 14. Static Drain-Source on Resistance

Package Dimensions

TO-220F-4L





## Package Dimensions (Continued)

## TO-220F-4L(Forming)

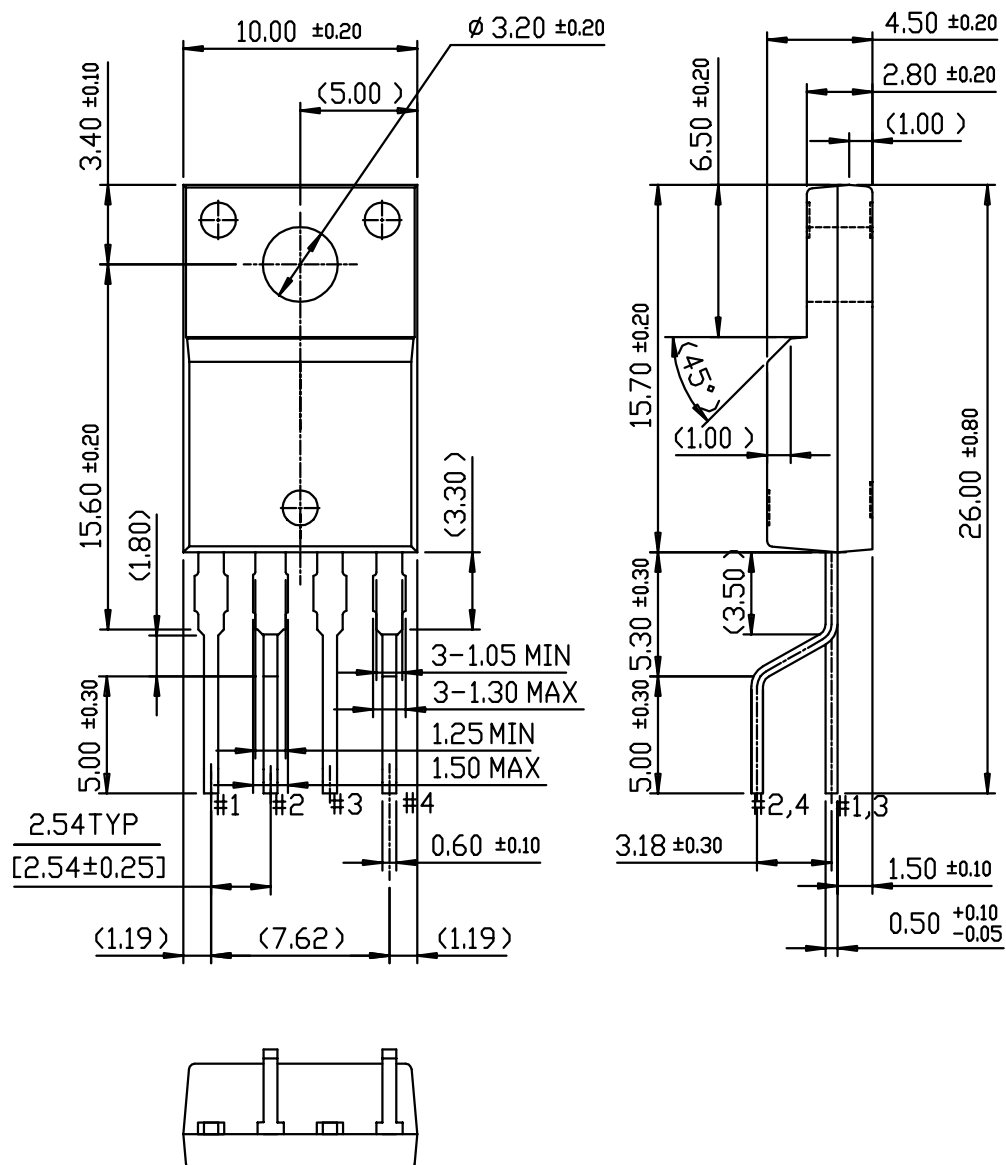

Package Dimensions (Continued)

8-DIP

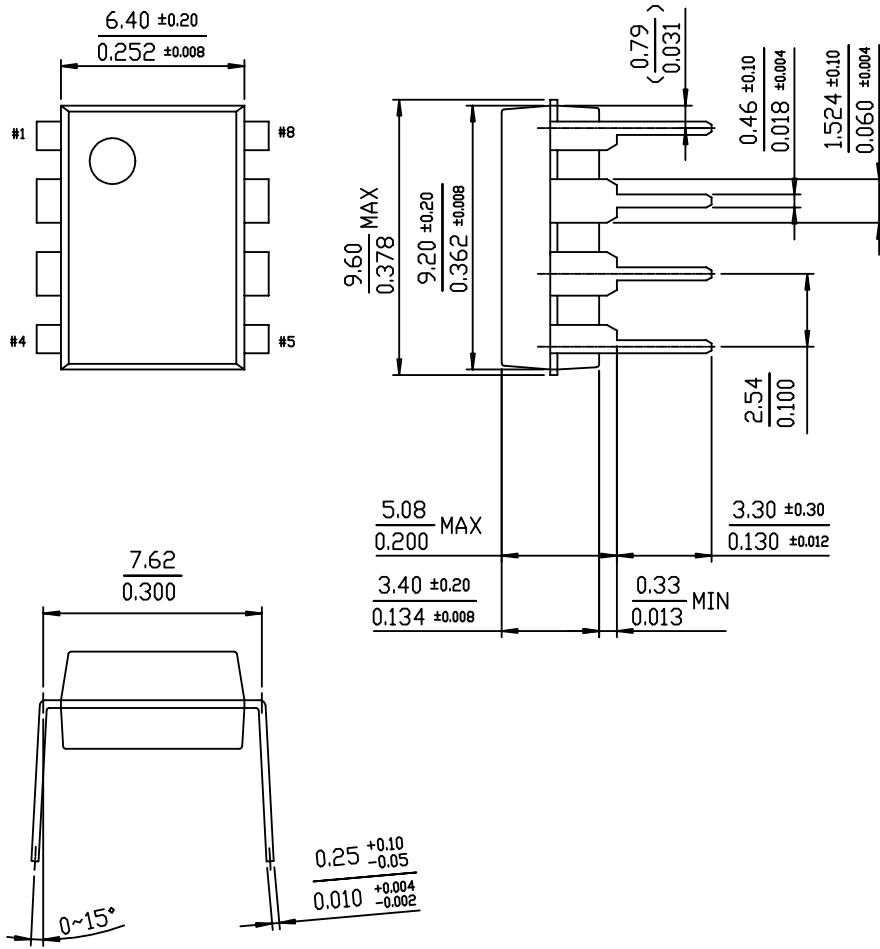

## Ordering Information

Product Number	Package	Marking Code	BVDSS	FOSC	RDS(on)
KA5H0365RTU	TO-220F-4L	5H0365R	650V	100kHz	3.6Ω
KA5H0365RYDTU	TO-220F-4L(Forming)				
KA5M0365RTU	TO-220F-4L	5M0365R	650V	67kHz	3.6Ω
KA5M0365RYDTU	TO-220F-4L(Forming)				
KA5L0365RTU	TO-220F-4L	5L0365R	650V	50kHz	3.6Ω
KA5L0365RYDTU	TO-220F-4L(Forming)				
KA5M0365RN	8-DIP	5M0365R	650V	67kHz	3.6Ω
KA5L0365RN	8-DIP	5L0365R	650V	50kHz	3.6Ω
Product Number	Package	Marking Code	BVDSS	FOSC	RDS(on)
KA5H0380RTU	TO-220F-4L	5H0380R	800V	100kHz	4.6Ω
KA5H0380RYDTU	TO-220F-4L(Forming)				
KA5M0380RTU	TO-220F-4L	5M0380R	800V	67kHz	4.6Ω
KA5M0380RYDTU	TO-220F-4L(Forming)				
KA5L0380RTU	TO-220F-4L	5L0380R	800V	50kHz	4.6Ω
KA5L0380RYDTU	TO-220F-4L(Forming)				

TU :Non Forming Type

YDTU : Forming type

**DISCLAIMER**

FAIRCHILD SEMICONDUCTOR RESERVES THE RIGHT TO MAKE CHANGES WITHOUT FURTHER NOTICE TO ANY PRODUCTS HEREIN TO IMPROVE RELIABILITY, FUNCTION OR DESIGN. FAIRCHILD DOES NOT ASSUME ANY LIABILITY ARISING OUT OF THE APPLICATION OR USE OF ANY PRODUCT OR CIRCUIT DESCRIBED HEREIN; NEITHER DOES IT CONVEY ANY LICENSE UNDER ITS PATENT RIGHTS, NOR THE RIGHTS OF OTHERS.

**LIFE SUPPORT POLICY**

FAIRCHILD'S PRODUCTS ARE NOT AUTHORIZED FOR USE AS CRITICAL COMPONENTS IN LIFE SUPPORT DEVICES OR SYSTEMS WITHOUT THE EXPRESS WRITTEN APPROVAL OF THE PRESIDENT OF FAIRCHILD SEMICONDUCTOR CORPORATION. As used herein:

1. Life support devices or systems are devices or systems which, (a) are intended for surgical implant into the body, or (b) support or sustain life, and (c) whose failure to perform when properly used in accordance with instructions for use provided in the labeling, can be reasonably expected to result in a significant injury of the user.
2. A critical component in any component of a life support device or system whose failure to perform can be reasonably expected to cause the failure of the life support device or system, or to affect its safety or effectiveness.