

BN 1684 - DIN 9021 - ~ISO 7093

Flat washers
without chamfer

DIN 9021
~ISO 7093
~UNI 6593

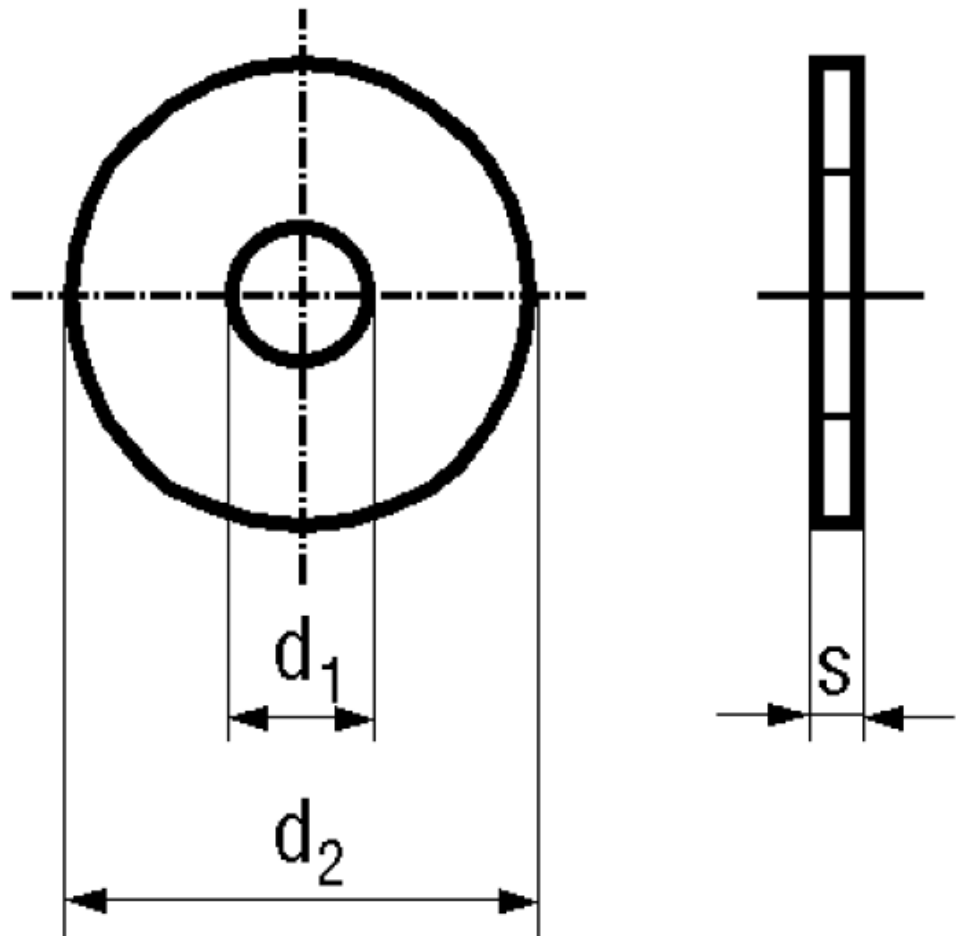

Material	Stainless steel	Hardness	140HV
Quality	A4		

Article No. - 1396994	
fit for	M3
d_1	3,2
d_2	9
s	0,8