

# Features

## Regulated Converters

- Very Compact Low AC/DC Power Supply
- High Efficiency
- Single & Dual Output Options
- Continuous Short Circuit Protection
- Isolated Output 3.75kVAC/1 min
- EN55022 Class B Compliant
- High Operating Temperature
- Low Standby Power Consumption

# POWERLINE

AC/DC-Converter  
with 3 year Warranty



## 10 Watt Single / Dual Output



E224736



**EN60950-1 Certified**  
**UL60950-1 Certified**  
**CE marked**

# RAC10-C/277

## Derating-Graph (Ambient Temperature)

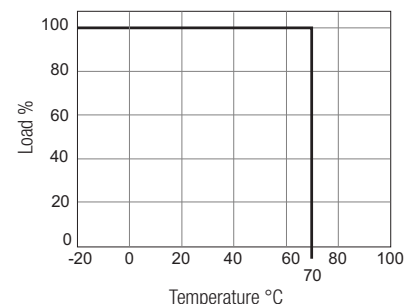

### Selection Guide

Part Number	Input Range (VAC)	Output Voltage (VDC)	Output Current (mA)	Efficiency (typ.) (%)	Max. Capacitive Load (μF) <sup>(1+2)</sup>
RAC10-3.3SC/277	80-305	3.3	2500	75	50000
RAC10-05SC/277	80-305	5	2000	78	36000
RAC10-12SC/277	80-305	12	840	80	8600
RAC10-15SC/277	80-305	15	670	78	6000
RAC10-24SC/277	80-305	24	420	80	2700
RAC10-05DC/277	80-305	±5	±1000	77	±21000
RAC10-12DC/277	80-305	±12	±420	79	±3700
RAC10-15DC/277	80-305	±15	±340	79	±2900

### Specifications (measured at TA 25°C, full load after warm-up)

Input Voltage Range (with Derating)	80-305VAC or 113-430VDC	
Rated Power	10 Watts	
Input Frequency Range (for AC Input)	47-63Hz	
Input Current (full load)	115VAC	250mA typ.
	230VAC	160mA typ.
No Load Power Consumption	230VAC	300mW max.
Inrush Current (cold Start-Up)	115VAC	15A max.
	230VAC	30A max.
Leakage Current	250VAC/50Hz	0.25mA max.
External Fuse Recommended	1.5A slow blow type	
Output Voltage Accuracy	3.3V	±3% typ.
	all others	±2% typ.
Line Voltage Regulation	(low line, high line at full load) ±0.3% typ.	
Load Voltage Regulation (0 -100% Load)	3.3V, 5V	-1.5% typ.
	12V	±1% typ.
	all others	±0.5% typ.
Minimum Load	0%	
Output Ripple and Noise (with 0.1μF across outputs @20mHz bandwidth)	3.3V / 5V	50mVp-p typ.
	12V / 15V / 24V	125mVp-p typ.
	±5	200mVp-p typ.
	±12	125mVp-p typ.
	±15	200mVp-p typ.
Operating Frequency	100kHz	
Hold-up time	230VAC/50Hz	60ms min.
Isolation Voltage (input to output)	3.75kVAC / 1minute	
Short Circuit Protection	Hiccup, Automatic Restart	

continued on next page

Refer to Application Notes

**Specifications** (measured at TA 25°C, full load after warm-up)

Output Overvoltage Protection	Latch off	
Over Voltage Category	OVC II	
Overcurrent Protection	Automatic Recovery	
Operating Temperature Range	(free air convection, with derating)	-20°C to +70°C
Storage Temperature Range	-40°C to +7 5°C	
Humidity	95% RH max.	
Case Material	Epoxy with Fibreglass (UL94V-0)	
Dimension (L x W x H)	52.4 x 27.4 x 23.5mm	
Package Weight	62g±5g	
EMC	EMI	EN 55022 Class B
	EMS	EN 55024
Certifications	UL General Safety (Report: E224736)	UL60950-1
	EMC (Report: T121026N02-E)	EN55022, EN55024
MTBF (+25°C)	using MIL-HDBK-217F	320 x 10 <sup>3</sup> hours
(+70°C)	using MIL-HDBK-217F	120 x 10 <sup>3</sup> hours

Input Voltage vs Load

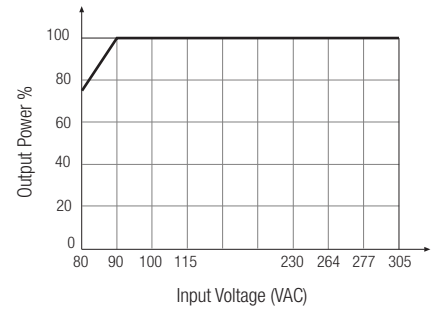

Notes:

Note1: Measured @ 230VAC / 50Hz / Ta=25°C with constant resistant mode at full load.

Note2: If used @ 115VAC / 60Hz with full load, max. capacitive load is less, please contacte RECOM for detailed information.

**Characteristics** (measured @ 115/230VAC, 50/60Hz after warm up)

## RAC10-xxSC/277

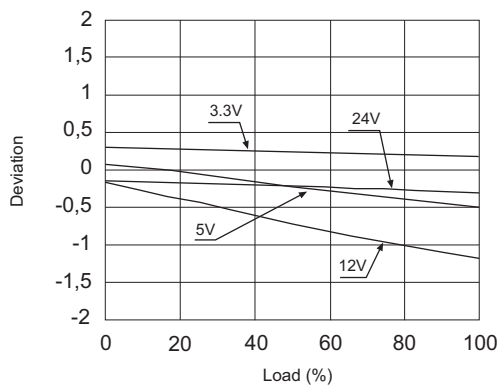
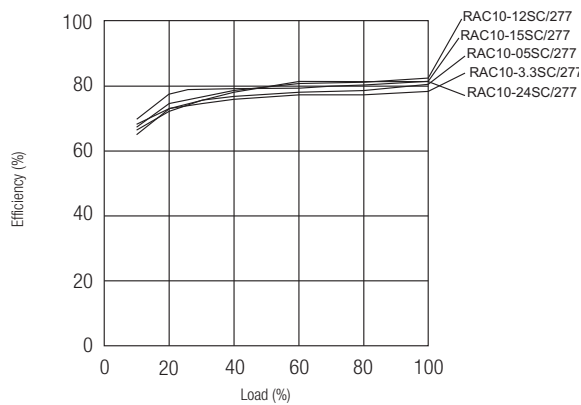

## RAC10-xxDC/277

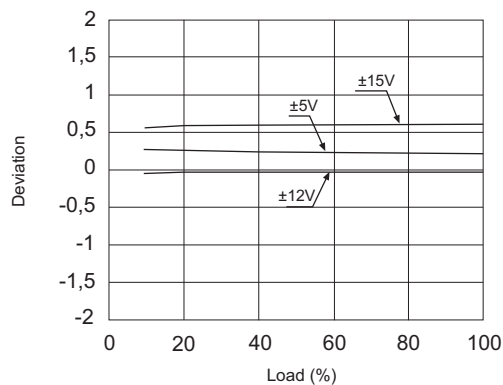
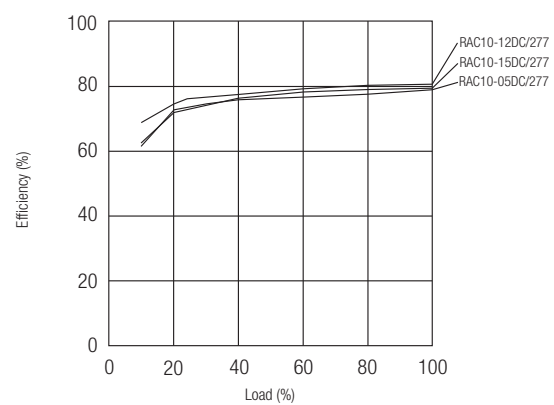

## Application Notes

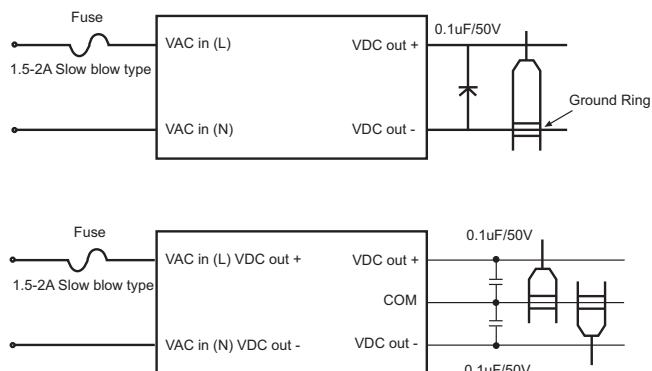

1. Recommended external input fuse 1.5A / slow blow type.
2. Do not use scope ground lead to measure the output ripple & noise.

## Standard Application Circuit

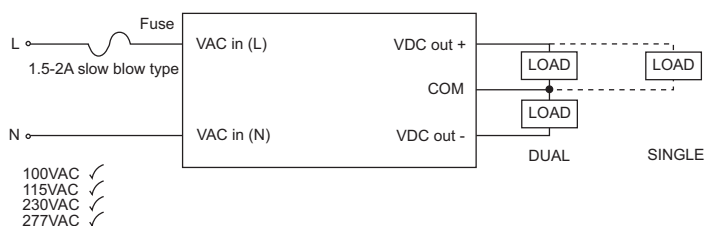

## Standard Package Style and Pinning

### RAC10-xxSC/277

RAC10/277

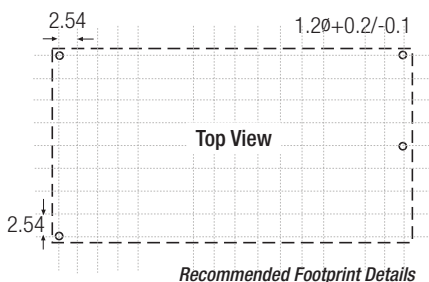
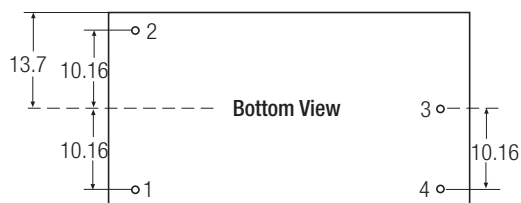
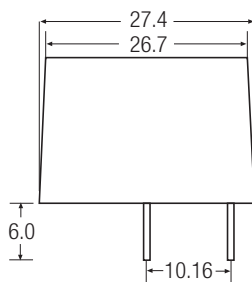
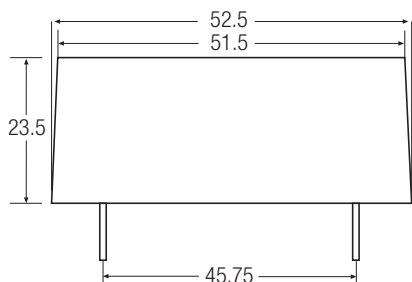

#### Pin Connections-

Pin #	Single Out
1	VAC in (N)
2	VAC in (L)
3	-VDC out
4	+VDC out

XX.X ± 0.5 mm  
XX.XX ± 0.25 mm

# POWERLINE

AC/DC-Converter

# RAC10-xxS\_DC /277 Series

Standard Package Style and Pinning

## RAC10-xxDC/277

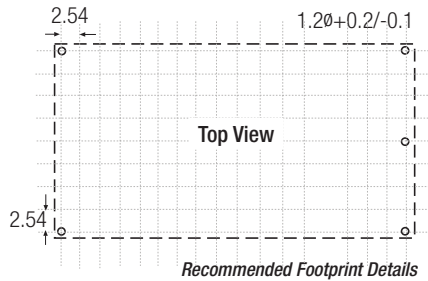
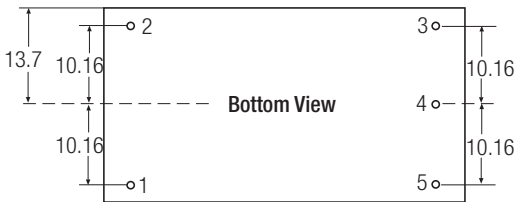
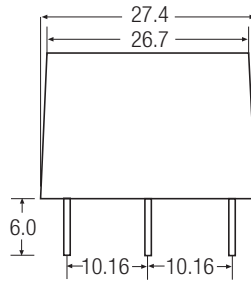
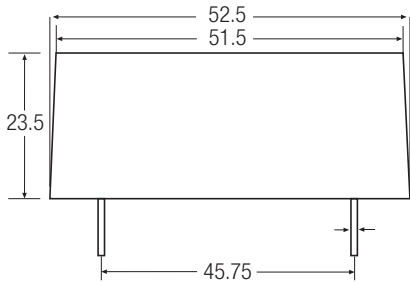

Recommended Footprint Details

### Pin Connections-

Pin #	Single Out
1	VAC in (N)
2	VAC in (L)
3	-VDC out
4	COM
5	+VDC out

XX.X ± 0.5 mm  
XX.XX ± 0.25 mm

The product information and specifications are subject to change without prior notice. All products are designed for non-safety critical commercial and industrial applications. The Buyer agrees to implement safeguards that anticipate the consequences of any failures that might cause harm, loss of life and/or damage property.