

**FEATURES:**

- 3 Pin SIP Package
- Pin-out compatible with LM78XX Linear Regulators
- Short Circuit Protection
- Non-Isolated Regulated Outputs
- Operating temperature -40°C to +85°C
- Wide input range
- Very High Efficiency Up To 96%
- Low ripple and noise

**Models
Single output**

Model	Input Voltage (V)	Output Voltage (V)	Output Current max (A)	Efficiency Vin Min (%)	Efficiency Vin Max (%)
AMSR1-783.3-NZ	4.75-28	3.3	1	90	83
AMSR1-7805-NZ	6.5-32	5	1	93	88
AMSR1-786.5-NZ	9.0-32	6.5	1	94	90
AMSR1-7809-NZ	12-32	9	1	95	92
AMSR1-7812-NZ	16-32	12	1	96	94
AMSR1-783.3L-NZ	4.75-28	3.3	1	90	83
AMSR1-7805L-NZ	6.5-32	5	1	93	88
AMSR1-786.5L-NZ	9.0-32	6.5	1	94	90
AMSR1-7809L-NZ	12-32	9	1	95	92
AMSR1-7812L-NZ	16-32	12	1	96	94

Input Specifications

Input Specifications	Nominal	Typical	Maximum	Units
Voltage range	See the table above			VDC
Filter	Capacitor			
Quiescent Current	Vin=(LL-HL) at full load	5	7	mA
Short Circuit consumption		0.5	1.2	W

Output Specifications

Output Specifications	Conditions	Typical	Maximum	Units
Voltage accuracy	100% load	±3		%
Short Circuit protection		Continuous.		
Short circuit restart		Auto recovery		
Output current limit			2	A
Thermal shutdown	Internal IC junction	150		°C
Dynamic load stability	10-100% load		±100	mV
Line voltage regulation	Vin=(LL-HL) at full load	±0.4		%
Load voltage regulation	10-100% load	±0.6		%
Temperature coefficient	-40°C to +85°C ambient	±0.02		%/°C
Ripple & Noise	20MHz Bandwidth	35		mV p-p
Maximum Capacitive Load			2000	µF

General Specifications

Input Specifications	Conditions	Typical	Maximum	Units
Switching frequency	100% load	330		KHz
Operating temperature	With derating above 71°C	-40 to +85		°C
Storage temperature		-55 to +125		°C
Max Case temperature			100	°C
Cooling	Free air convection			
Humidity			95	%
Case material	Non-conductive black plastic (UL94V-0 rated)			
Weight		3.7		g
Dimensions (L x W x H)		0.45 X 0.35 X 0.69 inch	11.50 X 8.90 X 17.50 mm	
MTBF	> 2 000 000 hrs (MIL-HDBK-217F, Ground Benign, t=+25°C)			
Soldering Temperature	1.5 mm from case for 10 sec		300	°C

NOTE: All specifications in this datasheet are measured at an ambient temperature of 25°C, humidity<75%, nominal input voltage and at rated output load unless otherwise specified.

Pin Out Specifications

Pin	Single
1	+Vin
2	GND
3	+Vout

Dimensions

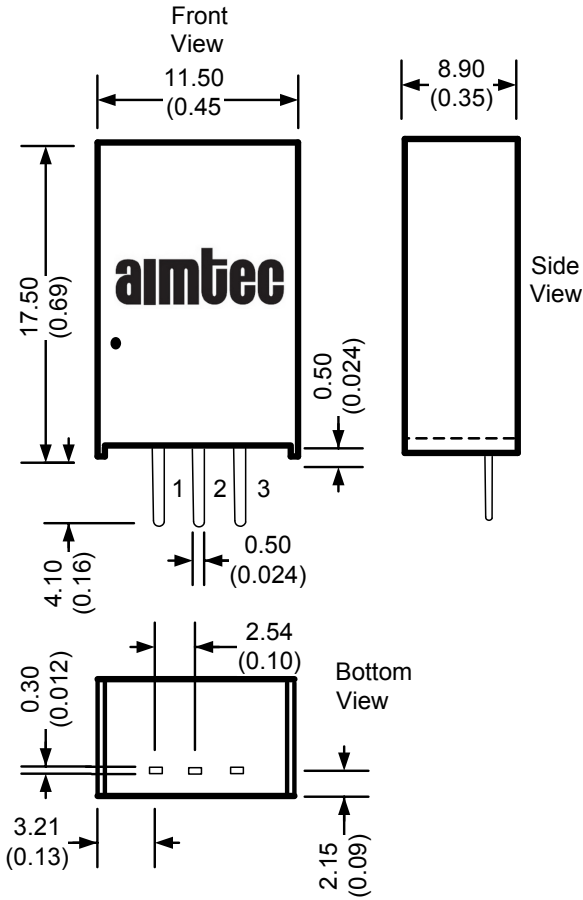

Footprint

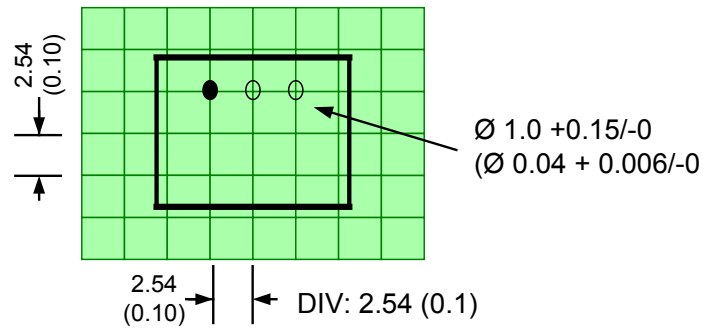

Dimensions are typical values: mm (inch)
 General Tolerance: ± 0.25 (± 0.01)
 Pin Tolerance: ± 0.1 (± 0.004)

L Models

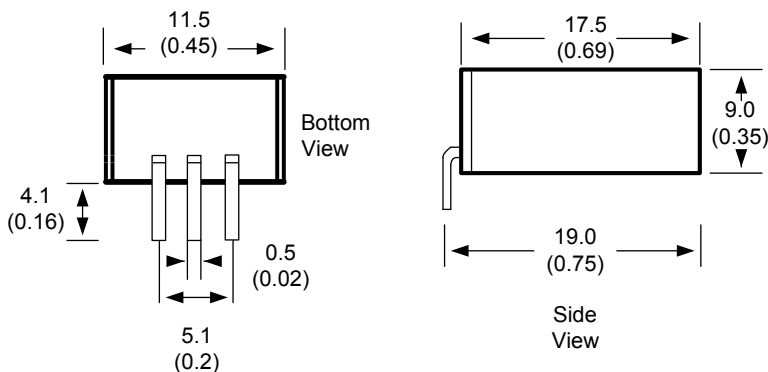

Footprint

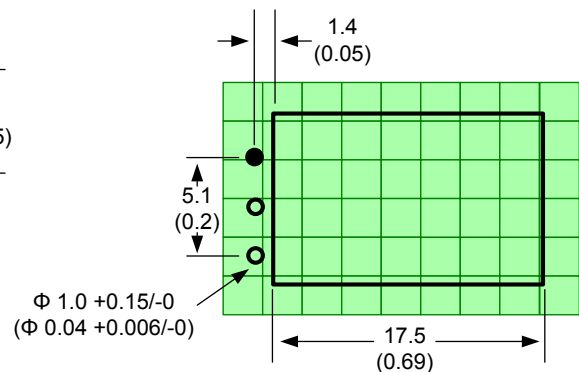

Typical Application Circuit

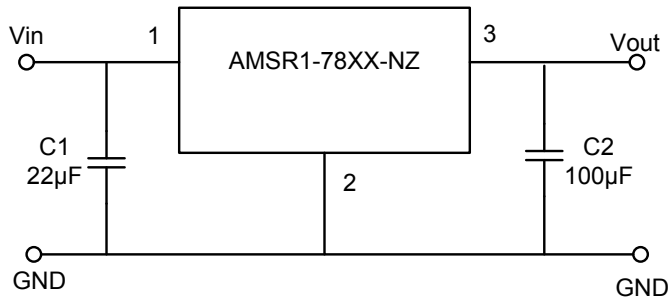

C1: A low ESR capacitor is required to keep the noise of the converter to a minimum. Ceramic capacitors are recommended, but tantalum or electrolytic may be used. Typical value is 22µF / 50V.
 C2: Installation of C2 is recommended but optional. Typical recommended value is 100µF / 25V electrolytic.
NOTE: This part is not designed for parallel operation.

Recommended Circuits Conducted and Radiated Emissions

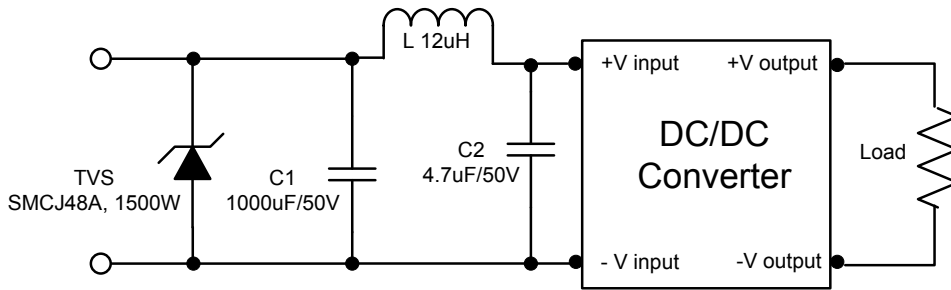

Derating

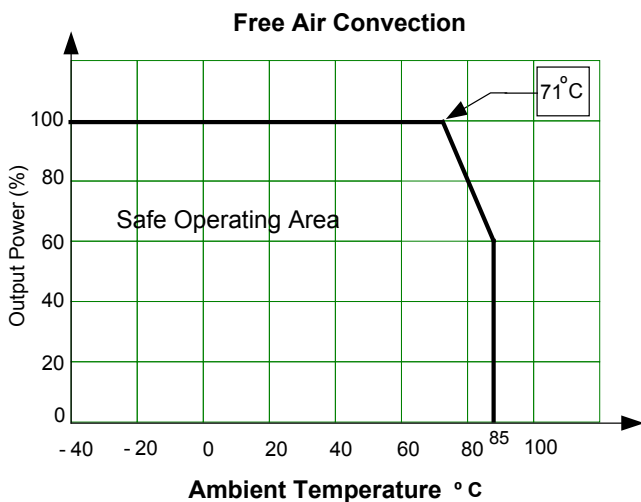

NOTE: 1. Datasheets are updated as needed and as such, specifications are subject to change without notice. Once printed or downloaded, datasheets are no longer controlled by Aimtec; refer to www.aimtec.com for the most current product specifications. 2. Product labels shown, including safety agency certifications on labels, may vary based on the date manufactured. 3. Mechanical drawings and specifications are for reference only. 4. All specifications are measured at an ambient temperature of 25°C, humidity<75%, nominal input voltage and at rated output load unless otherwise specified. 5. Aimtec may not have conducted destructive testing or chemical analysis on all internal components and chemicals at the time of publishing this document. CAS numbers and other limited information are considered proprietary and may not be available for release. 6. This product is not designed for use in critical life support systems, equipment used in hazardous environments, nuclear control systems or other such applications which necessitate specific safety and regulatory standards other the ones listed in this datasheet. 7. Warranty is in accordance with Aimtec's standard Terms of Sale available at www.aimtec.com.