

# SKKT 92, SKKH 92, SKKT 92B



**SEMIPACK<sup>®</sup> 1**

## Thyristor / Diode Modules

### SKKT 92

### SKKT 92B

### SKKH 92

### Features

- Heat transfer through aluminium oxide ceramic isolated metal baseplate
- Hard soldered joints for high reliability
- UL recognized, file no. E 63 532

### Typical Applications\*

- DC motor control (e. g. for machine tools)
- AC motor soft starters
- Temperature control (e. g. for ovens, chemical processes)
- Professional light dimming (studios, theaters)

1) See the assembly instructions

$V_{RSM}$ V	$V_{RRM}, V_{DRM}$ V	$I_{TRMS} = 150$ A (maximum value for continuous operation)		
		$I_{TAV} = 95$ A (sin. 180; $T_c = 85$ °C)		
900	800	SKKT 92/08E	SKKT 92B08E	SKKH 92/08E
1300	1200	SKKT 92/12E	SKKT 92B12E	SKKH 92/12E
1500	1400	SKKT 92/14E	SKKT 92B14E	SKKH 92/14E
1700	1600	SKKT 92/16E	SKKT 92B16E	SKKH 92/16E
1900	1800	SKKT 92/18E	SKKT 92B18E	SKKH 92/18E

Symbol	Conditions	Values	Units
$I_{TAV}$	sin. 180; $T_c = 85$ (100) °C;	95 (68 )	A
$I_D$	P3/180; $T_a = 45$ °C; B2 / B6	70 / 85	A
	P3/180F; $T_a = 35$ °C; B2 / B6	140 / 175	A
$I_{RMS}$	P3/180F; $T_a = 35$ °C; W1 / W3	190 / 3 * 135	A
$I_{TSM}$	$T_{vj} = 25$ °C; 10 ms	2000	A
	$T_{vj} = 125$ °C; 10 ms	1750	A
$i^2t$	$T_{vj} = 25$ °C; 8,3 ... 10 ms	20000	A <sup>2</sup> s
	$T_{vj} = 125$ °C; 8,3 ... 10 ms	15000	A <sup>2</sup> s
$V_T$	$T_{vj} = 25$ °C; $I_T = 300$ A	max. 1,65	V
$V_{T(TO)}$	$T_{vj} = 125$ °C	max. 0,9	V
$r_T$	$T_{vj} = 125$ °C	max. 2	mΩ
$I_{DD}; I_{RD}$	$T_{vj} = 125$ °C; $V_{RD} = V_{RRM}; V_{DD} = V_{DRM}$	max. 20	mA
$t_{gd}$	$T_{vj} = 25$ °C; $I_G = 1$ A; $di_G/dt = 1$ A/μs	1	μs
$t_{gr}$	$V_D = 0,67 * V_{DRM}$	2	μs
$(di/dt)_{cr}$	$T_{vj} = 125$ °C	max. 150	A/μs
$(dv/dt)_{cr}$	$T_{vj} = 125$ °C	max. 1000	V/μs
$t_q$	$T_{vj} = 125$ °C	100	μs
$I_H$	$T_{vj} = 25$ °C; typ. / max.	150 / 250	mA
$I_L$	$T_{vj} = 25$ °C; $R_G = 33$ Ω; typ. / max.	300 / 600	mA
$V_{GT}$	$T_{vj} = 25$ °C; d.c.	min. 3	V
$I_{GT}$	$T_{vj} = 25$ °C; d.c.	min. 150	mA
$V_{GD}$	$T_{vj} = 125$ °C; d.c.	max. 0,25	V
$I_{GD}$	$T_{vj} = 125$ °C; d.c.	max. 6	mA
$R_{th(j-c)}$	cont.; per thyristor / per module	0,28 / 0,14	K/W
$R_{th(j-c)}$	sin. 180; per thyristor / per module	0,3 / 0,15	K/W
$R_{th(j-c)}$	rec. 120; per thyristor / per module	0,32 / 0,16	K/W
$R_{th(c-s)}$	per thyristor / per module	0,2 / 0,1	K/W
$T_{vj}$		- 40 ... + 125	°C
$T_{stg}$		- 40 ... + 125	°C
$V_{isol}$	a. c. 50 Hz; r.m.s.; 1 s / 1 min.	3600 / 3000	V~
$M_s$	to heatsink	5 ± 15 % <sup>1)</sup>	Nm
$M_t$	to terminals	3 ± 15 %	Nm
$a$		5 * 9,81	m/s <sup>2</sup>
$m$	approx.	95	g
Case	SKKT	A 46	
	SKKT ...B	A 48	
	SKKH	A 47	



SKKT

SKKH

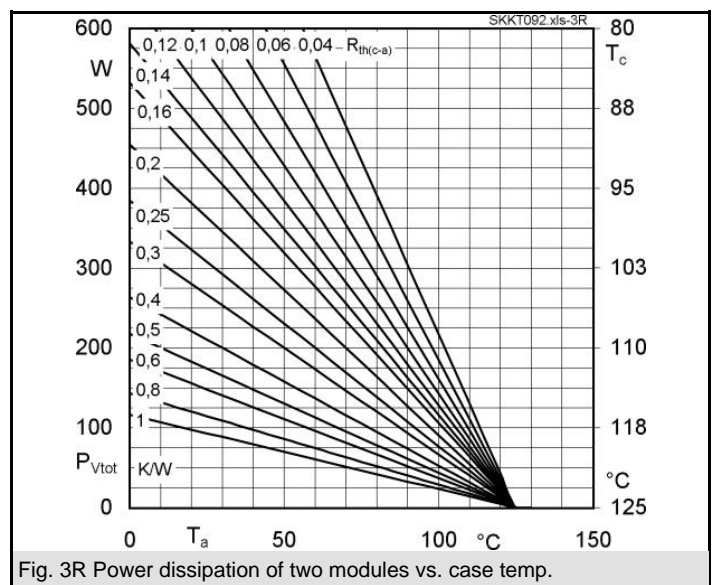
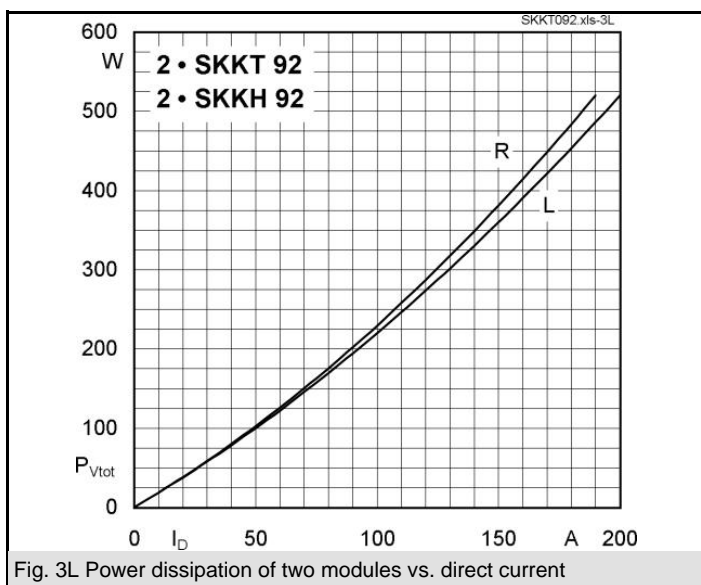
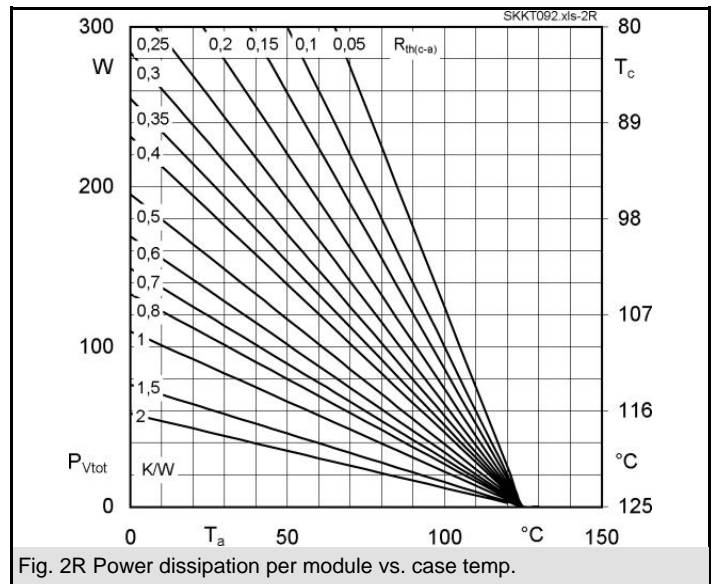
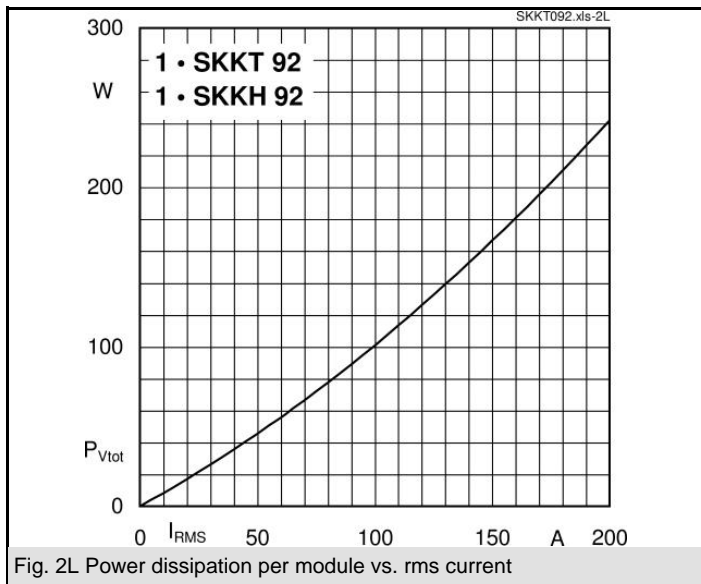
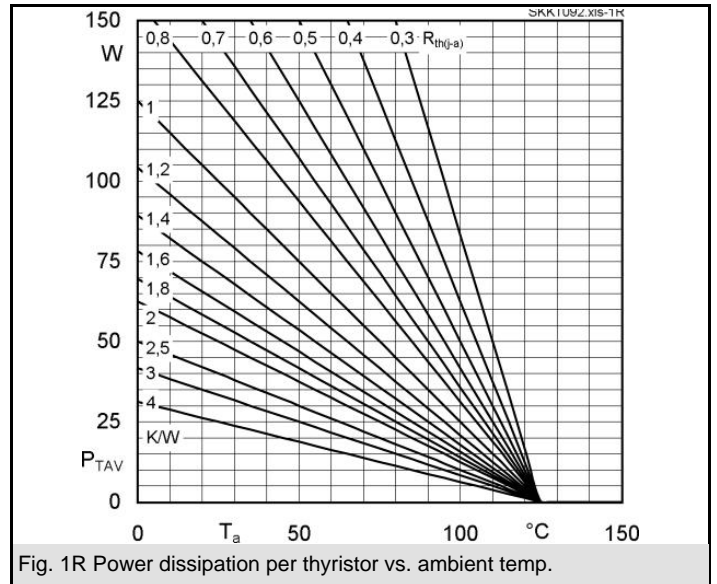
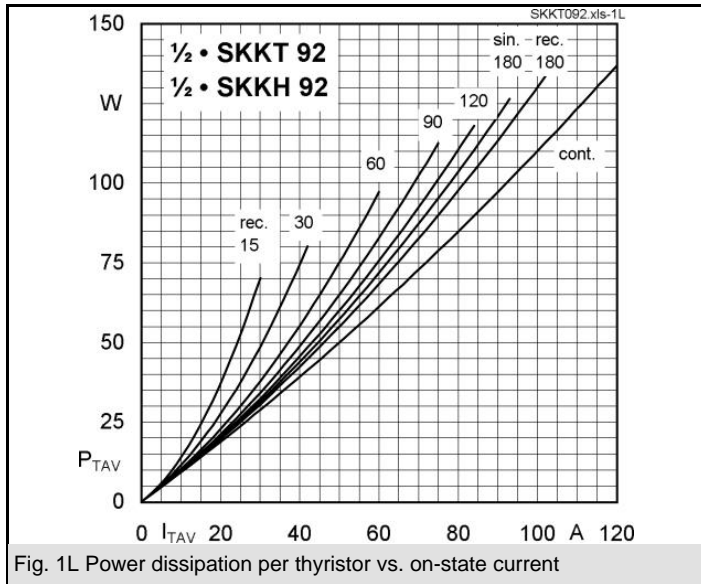

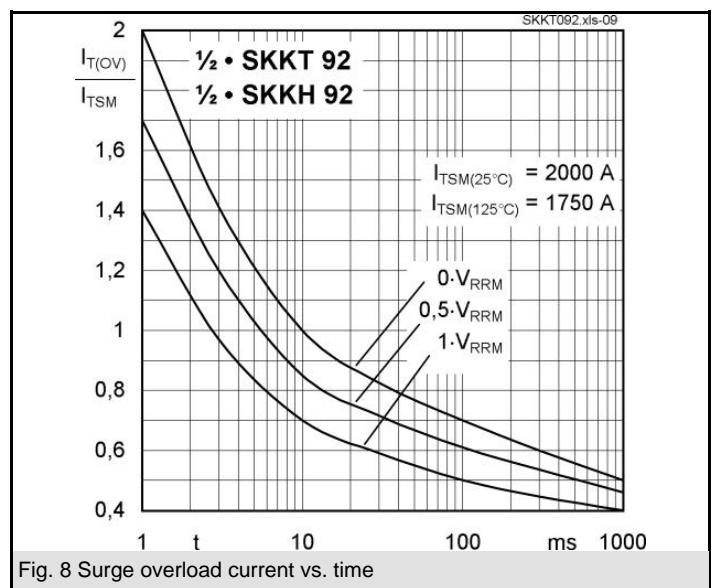
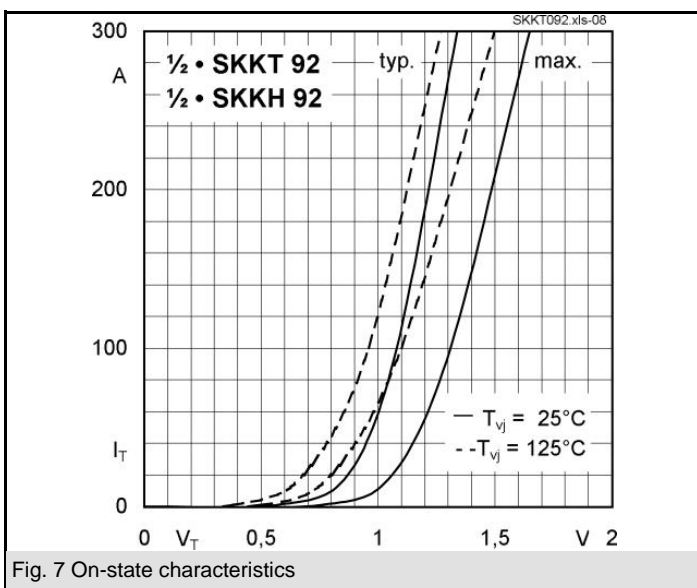
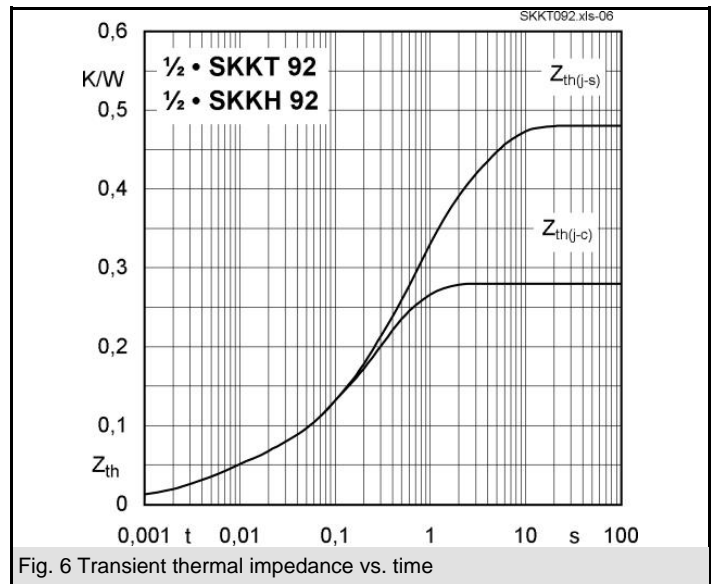
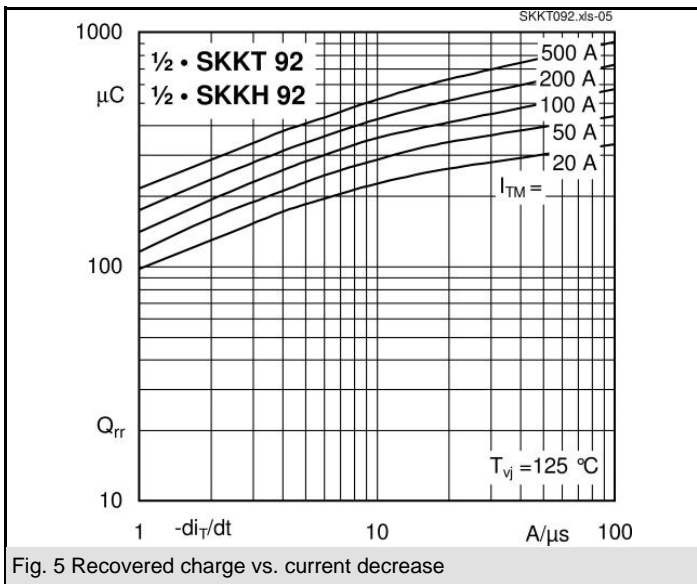
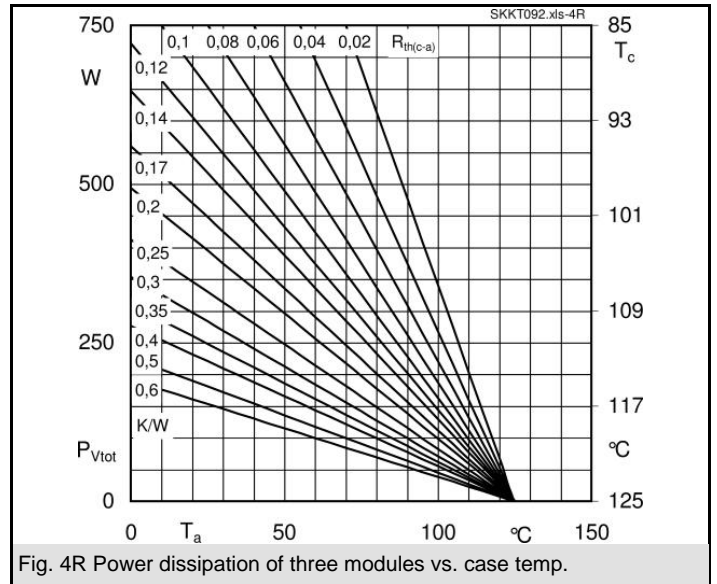
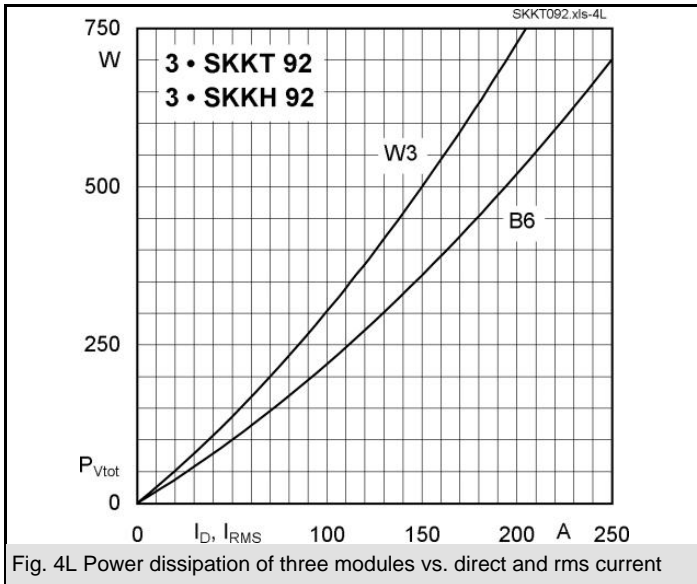

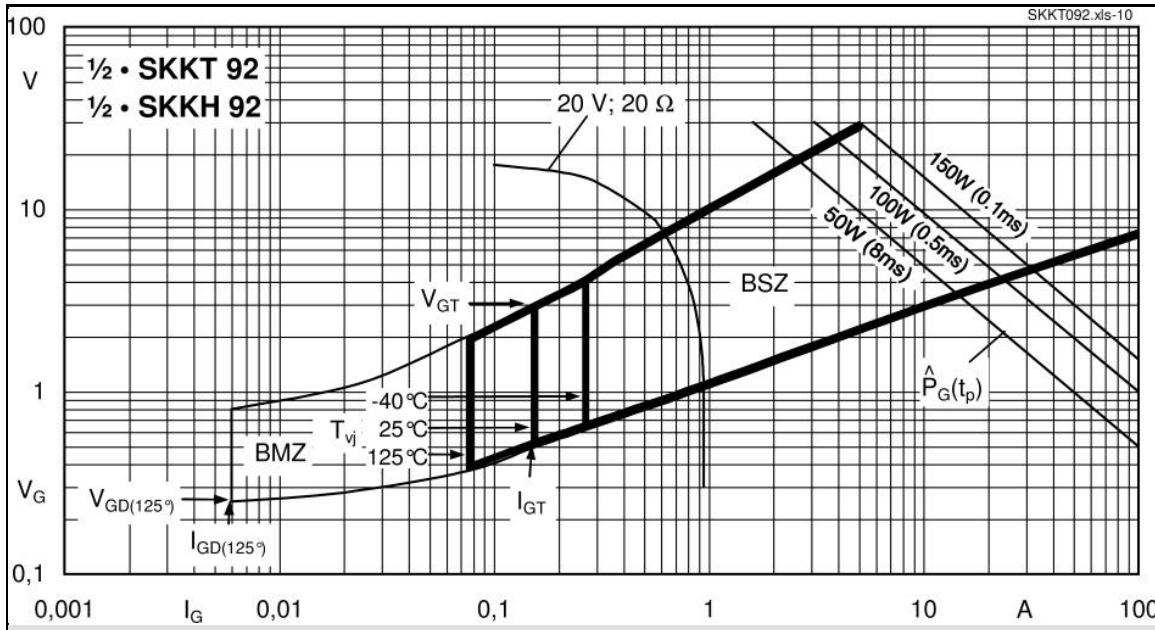
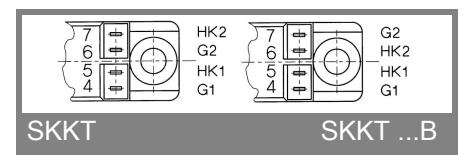
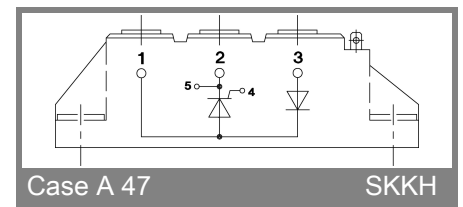
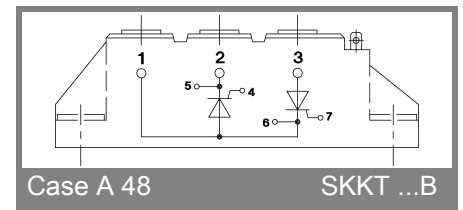
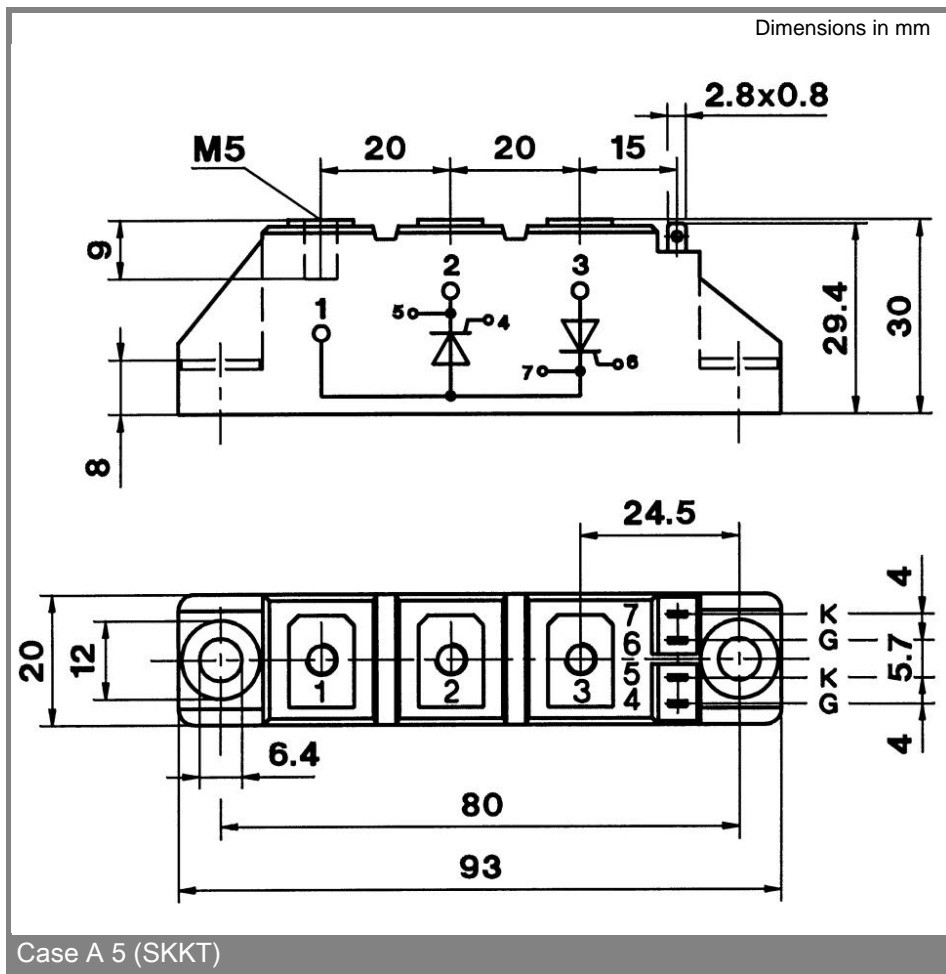

Fig. 9 Gate trigger characteristics



\* The specifications of our components may not be considered as an assurance of component characteristics. Components have to be tested for the respective application. Adjustments may be necessary. The use of SEMIKRON products in life support appliances and systems is subject to prior specification and written approval by SEMIKRON. We therefore strongly recommend prior consultation of our personal.