

**LL grade**

**For professional switch-mode power supplies**

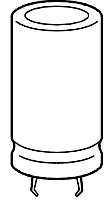

KAL0274-A

**Construction**

- Charge-discharge proof, polar
- Aluminum case, fully insulated
- Snap-in solder pins to hold component in place on PC-board
- Minus pole marking on case surface
- Minus pole not insulated from case
- All-welded construction

**Terminals**

- Standard version with 2 terminals  
2 lengths available: 6,3 and 4,5 mm
- 3 terminals (terminal arrangement ensures correct insertion)

**Features**

- High reliability
- High ripple current capability and small dimensions
- Wide temperature range
- Low equivalent series resistance  $R_{ESR}$
- Different case sizes available for each capacitance value

**Applications**

- Professional switch-mode power supplies in industrial electronics and in data processing equipment
- Switch-mode power supplies in entertainment electronics

**Specifications and characteristics in brief**

	B 41 503	B 43 503
Rated voltage $U_R$	10 ... 100 V–	200 ... 500 V–
Surge voltage $U_S$	$1,15 \cdot U_R$	$1,15 \cdot U_R$ (for $U_R \leq 250$ V–) $1,10 \cdot U_R$ (for $U_R \geq 350$ V–)
Rated capacitance $C_R$	470 ... 33 000 $\mu$ F	15 ... 1 500 $\mu$ F
Capacitance tolerance	$\pm 20\% \triangleq M$	$\pm 20\% \triangleq M$
Useful life		
40 °C, $U_R$	> 200 000 h ( $2,1 \cdot I_{-R,105^\circ C}$ )	> 200 000 h ( $2,7 \cdot I_{-R,105^\circ C}$ )
85 °C, $U_R$ ; $I_{-max}$	> 4 000 h	> 12 000 h
105 °C, $U_R$ ; $I_{-R}$	> 2 500 h	> 5 000 h
Failure percentage	$\leq 1\%$ (during useful life)	$\leq 1\%$ (during useful life)
Failure rate	$\leq 40$ fit ( $\leq 40 \cdot 10^{-9}/h$ )	$\leq 40$ fit ( $\leq 40 \cdot 10^{-9}/h$ )



**B 41 503**  
**B 43 503**

**Not for new design**

**Specifications and characteristics in brief**

Voltage endurance test	2 000 h, 105 °C (at $U_R$ )	2 000 h, 105 °C (at $U_R$ )
Leakage current $I_{lka}$ (5 min, 20 °C)	$I_{lka} \leq 0,3 \mu A \cdot \left( \frac{C_R}{\mu F} \cdot \frac{U_R}{V} \right)^{0,7} + 4 \mu A$	
Self-inductance $L_{ESL}$	approx. 20 nH	
	B 41 503	B 43 503
IEC climatic category	in accordance with IEC 68–1 40/105/56 (–40 °C/+105 °C, 56 days damp heat test)	
		25/105/56 (–25 °C/+105 °C, 56 days damp heat test)
Detail specification	similar to CECC 30 301-806	
Sectional specification	IEC 384–4	
Vibration resistance	in accordance with IEC 68–2–6, test Fc: displacement amplitude 0,35 mm, frequency range 10 ... 55 Hz, acceleration max. 5 g, duration 3 × 2 h	

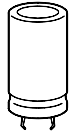

Dimensional drawings

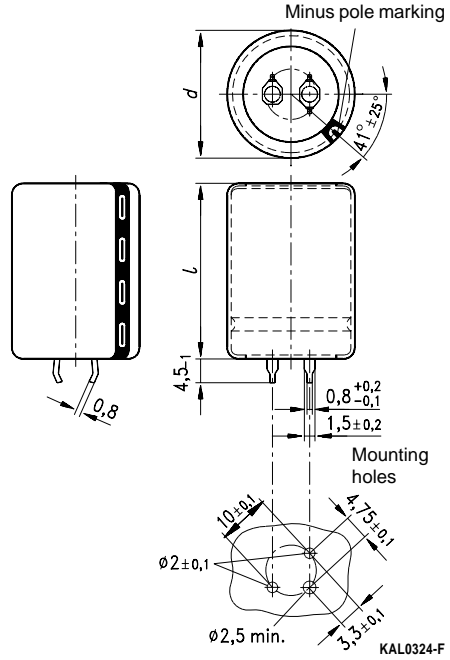
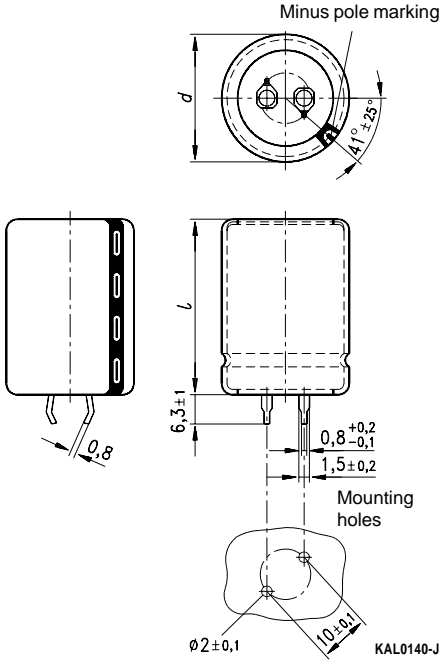

Snap-in terminals, standard (length  $6,3 \pm 1$  mm). Also available in a shorter version with a length of  $4,5 - 1$  mm. For packing mode and ordering example see [page 247](#).

Snap-in capacitors are also available with 3 terminals. For packing mode and ordering example see [page 247](#).

Dimensions (mm)		Approx. weight (g)	Packing units (pieces)
$d + 1$	$l \pm 2$		
22	25	9	160
22	30	12	160
22	35	15	160
22	40	18	160
25	25	13	130
25	30	17	130
25	35	19	130
25	40	22	130
25	45	25	130

Dimensions (mm)		Approx. weight (g)	Packing units (pieces)
$d + 1$	$l \pm 2$		
30	30	23	80
30	35	29	80
30	40	36	80
30	45	41	80
30	50	46	80
35	25	25	60
35	30	31	60
35	35	37	60
35	40	44	60
35	45	52	60
35	50	59	60
35	55	66	60



**B 41 503**  
**B 43 503**

**Not for new design**

**Overview of available types**

**Type B 41 503**

$U_R$ (V-)	10	16	25	40	63	100
$C_R$ ( $\mu$ F)	Case dimensions $d \times l$ (mm)					
470						22 × 30 25 × 25
680						22 × 35 25 × 30
1 000					22 × 30 25 × 25	25 × 35 30 × 30
1 500					22 × 35 25 × 30	30 × 35
2 200				22 × 30 25 × 25	25 × 35 30 × 30	30 × 45
3 300			22 × 30 25 × 25	22 × 40 25 × 30	30 × 40	
4 700		22 × 30 25 × 25	22 × 35 25 × 30	25 × 40 30 × 30	30 × 45	
6 800	22 × 30 25 × 25	22 × 35 25 × 30	25 × 35 30 × 30	30 × 35		
10 000	22 × 35 25 × 30	25 × 35 30 × 30	30 × 35	30 × 50		
15 000	25 × 35 30 × 30	30 × 35	30 × 45			
22 000	30 × 35	30 × 45				
33 000	30 × 45					

The capacitance and voltage ratings listed above are available in different cases upon request. Other voltage and capacitance ratings are also available upon request.



Overview of available types

Type B 43 503

$U_R$ (V-)	200	250	400	450	500
$C_R$ ( $\mu$ F)	Case dimensions $d \times l$ (mm)				
15					22 × 25
22					22 × 30
33					22 × 35
47			22 × 25	22 × 35 25 × 30	25 × 35
68			22 × 30 25 × 25	25 × 35	25 × 45
100			22 × 35 25 × 30	30 × 35	30 × 45
150	22 × 25	22 × 30 25 × 25	25 × 40 30 × 30	30 × 45 35 × 25	
220	22 × 30 25 × 25	25 × 30 22 × 35	30 × 40 35 × 30	35 × 40	
330	22 × 35 25 × 30	25 × 35 30 × 30	30 × 50 35 × 35	35 × 50	
470	25 × 40 30 × 30	30 × 35	35 × 50		
560			35 × 55		
680	30 × 35	30 × 45			
1 000	35 × 45	35 × 45			
1 200	35 × 50				
1 500	35 × 55				

The capacitance and voltage ratings listed above are available in different cases upon request. Other voltage and capacitance ratings are also available upon request.



**B 41 503**  
**B 43 503**

**Not for new design**

**Technical data and ordering codes**

$U_R$	$C_R$	Case dimensions $d \times l$ mm	$R_{ESR, typ}$ 100 Hz 20 °C mΩ	$R_{ESR, max}$ 100 Hz 20 °C mΩ	$Z_{max}$ 10 kHz 20 °C mΩ	$I_{~max}$ 100 Hz 40 °C A	$I_{~max}$ 100 Hz 85 °C A	$I_{~R}^{1)}$ 100 Hz 105 °C A	Ordering code <sup>2)</sup>  Short code
<b>B41503-</b>									
10	6 800	22 × 30	55	83	72	4,9	3,5	1,6	-A3688-M
	6 800	25 × 25	55	83	72	4,9	3,5	1,6	-J3688-M
	10 000	22 × 35	44	66	59	5,9	4,2	1,9	-B3109-M
	10 000	25 × 30	44	66	59	5,9	4,2	1,9	-J3109-M
	15 000	25 × 35	36	54	49	6,8	4,8	2,2	-B3159-M
	15 000	30 × 30	36	54	49	6,8	4,8	2,2	-J3159-M
	22 000	30 × 35	31	46	43	8,1	5,7	2,6	-B3229-M
	33 000	30 × 45	27	41	39	9,6	6,8	3,1	-B3339-M
16	4 700	22 × 30	60	90	78	4,7	3,5	1,6	-A4478-M
	4 700	25 × 25	60	90	78	4,7	3,5	1,6	-J4478-M
	6 800	22 × 35	47	71	63	5,6	4,0	1,8	-B4688-M
	6 800	25 × 30	47	71	63	5,6	4,0	1,8	-J4688-M
	10 000	25 × 35	39	58	52	6,8	4,8	2,2	-B4109-M
	10 000	30 × 30	39	58	52	6,8	4,8	2,2	-J4109-M
	15 000	30 × 35	32	49	45	8,1	5,7	2,6	-B4159-M
	22 000	30 × 45	28	43	40	9,3	6,6	3,0	-B4229-M
25	3 300	22 × 30	64	97	83	4,6	3,3	1,5	-A5338-M
	3 300	25 × 25	64	97	83	4,6	3,3	1,5	-J5338-M
	4 700	22 × 35	51	77	67	5,3	3,7	1,7	-B5478-M
	4 700	25 × 30	51	77	67	5,3	3,7	1,7	-J5478-M
	6 800	25 × 35	42	62	56	6,5	4,6	2,1	-B5688-M
	6 800	30 × 30	42	62	56	6,5	4,6	2,1	-J5688-M
	10 000	30 × 35	35	52	48	7,8	5,5	2,5	-B5109-M
	15 000	30 × 45	30	45	42	9,0	6,4	2,9	-B5159-M

1) 120 Hz conversion factor of ripple current:  $I_{~} (120 \text{ Hz}) = 1,03 \cdot I_{~} (100 \text{ Hz})$

2) To obtain the required ordering code, prefix the type number to the short code. E. g.: B41503-A3688-M.



Technical data and ordering codes

$U_R$	$C_R$	Case dimensions $d \times l$ mm	$R_{ESR, typ}$ 100 Hz 20 °C mΩ	$R_{ESR, max}$ 100 Hz 20 °C mΩ	$Z_{max}$ 10 kHz 20 °C mΩ	$I_{-max}$ 100 Hz 40 °C A	$I_{-max}$ 100 Hz 85 °C A	$I_{-R}^{1)}$ 100 Hz 105 °C A	Ordering code 2)  Short code
<b>B41503-</b>									
40	2 200	22 × 30	72	110	92	4,3	3,1	1,4	-A7228-M
	2 200	25 × 25	72	110	92	4,3	3,1	1,4	-J7228-M
	3 300	22 × 40	54	82	71	5,4	3,9	1,8	-A7338-M
	3 300	25 × 30	54	82	71	5,4	3,9	1,8	-J7338-M
	4 700	25 × 40	44	66	59	6,2	4,8	2,2	-A7478-M
	4 700	30 × 30	44	66	59	6,2	4,8	2,2	-J7478-M
	6 800	30 × 35	37	55	50	7,4	5,3	2,4	-B7688-M
	10 000	30 × 50	31	47	44	9,2	6,5	3,0	-A7109-M
63	1 000	22 × 30	110	160	130	3,6	2,6	1,2	-A8108-M
	1 000	25 × 25	110	160	130	3,6	2,6	1,2	-J8108-M
	1 500	22 × 35	78	120	100	4,3	3,1	1,4	-B8158-M
	1 500	25 × 30	78	120	100	4,3	3,1	1,4	-J8158-M
	2 200	25 × 35	59	89	77	5,6	4,0	1,8	-B8228-M
	2 200	30 × 30	59	89	77	5,6	4,0	1,8	-J8228-M
	3 300	30 × 40	46	69	62	7,0	5,0	2,3	-A8338-M
	4 700	30 × 45	38	58	52	8,1	5,7	2,6	-B8478-M
100	470	22 × 30	160	240	200	2,9	2,1	0,96	-A9477-M
	470	25 × 25	160	240	200	2,9	2,1	0,96	-J9477-M
	680	22 × 35	120	180	150	3,4	2,4	1,1	-B9687-M
	680	25 × 30	120	180	150	3,4	2,4	1,1	-J9687-M
	1 000	25 × 35	87	130	110	4,6	3,1	1,4	-B9108-M
	1 000	30 × 30	87	130	110	4,6	3,1	1,4	-J9108-M
	1 500	30 × 35	64	97	83	5,6	4,0	1,8	-B9158-M
	2 200	30 × 45	50	75	66	7,1	5,1	2,3	-B9228-M

1) 120 Hz conversion factor of ripple current:  $I_{- (120 Hz)} = 1,03 \cdot I_{- (100 Hz)}$

2) To obtain the required ordering code, prefix the type number to the short code. E. g.: B41503-A7228-M.



**B 41 503**  
**B 43 503**

**Not for new design**

**Technical data and ordering codes**

$U_R$	$C_R$	Case dimensions $d \times l$ mm	$R_{ESR, typ}$ 100 Hz 20 °C mΩ	$R_{ESR, max}$ 100 Hz 20 °C mΩ	$Z_{max}$ 10 kHz 20 °C mΩ	$I_{-max}$ 100 Hz 40 °C A	$I_{-max}$ 100 Hz 85 °C A	$I_{-R}^{1)}$ 100 Hz 105 °C A	Ordering code <sup>2)</sup>  Short code
<b>B43503-</b>									
200	150	22 × 25	790	1400	1100	1,8	1,2	0,61	-D157-M
	220	22 × 30	540	900	750	2,4	1,6	0,79	-D227-M
	220	25 × 25	540	900	750	2,4	1,6	0,81	-M227-M
	330	22 × 35	360	600	500	3,0	2,0	1,0	-D337-M
	330	25 × 30	360	600	500	3,3	2,2	1,1	-M337-M
	470	25 × 40	250	420	350	4,2	2,8	1,4	-D477-M
	470	30 × 30	250	420	350	4,2	2,8	1,4	-L477-M
	680	30 × 35	170	280	230	5,1	3,4	1,7	-D687-M
	1 000	35 × 45	120	300	96	6,6	4,4	2,2	-A108-M90
	1 200	35 × 50	110	250	110	7,2	4,8	2,4	-A128-M90
1 500	35 × 55	100	200	120	7,6	5,0	2,5	-A158-M90	
250	150	22 × 30	790	1320	1100	2,1	1,4	0,69	-C2157-M
	150	25 × 25	790	1320	1100	2,1	1,4	0,70	-L2157-M
	220	25 × 30	540	900	750	2,7	1,8	0,91	-L2227-M
	220	22 × 35	540	900	750	2,7	1,8	0,89	-C2227-M
	330	25 × 35	360	600	500	3,6	2,4	1,2	-C2337-M
	330	30 × 30	360	600	500	3,6	2,4	1,2	-L2337-M
	470	30 × 35	250	420	350	4,5	3,0	1,5	-C2477-M
	680	30 × 45	170	280	230	6,0	4,0	2,0	-C2687-M
	1 000	35 × 45	120	300	96	6,6	4,4	2,2	-A2108-M90

1) 120 Hz conversion factor of ripple current:  $I_{-} (120 \text{ Hz}) = 1,03 \cdot I_{-} (100 \text{ Hz})$

2) To obtain the required ordering code, prefix the type number to the short code. E. g.: B43503-D157-M.





### Technical data and ordering codes

$U_R$	$C_R$	Case dimensions $d \times l$ mm	$R_{ESR, typ}$ 100 Hz 20 °C mΩ	$R_{ESR, max}$ 100 Hz 20 °C mΩ	$Z_{max}$ 10 kHz 20 °C mΩ	$I_{-max}$ 100 Hz 40 °C A	$I_{-max}$ 100 Hz 85 °C A	$I_{-R}^{1)}$ 100 Hz 105 °C A	Ordering code 2)  Short code
<b>B43503-</b>									
400	47	22 × 25	1900	3200	2700	1,1	0,74	0,37	-G476-M
	68	22 × 30	1300	2200	1810	1,4	0,94	0,47	-G686-M
	68	25 × 25	1300	2200	1900	1,4	0,96	0,48	-Q686-M
	100	22 × 35	1000	1600	1500	1,8	1,2	0,61	-G107-M
	100	25 × 30	1000	1600	1500	1,9	1,2	0,62	-Q107-M
	150	25 × 40	670	1100	920	2,5	1,7	0,84	-G157-M
	150	30 × 30	670	1100	920	2,5	1,7	0,83	-P157-M
	220	30 × 40	450	700	630	3,3	2,2	1,1	-G227-M
	220	35 × 30	630	1360	630	3,3	2,2	1,1	-A227-M90
	330	30 × 50	300	450	420	4,5	3,0	1,5	-F337-M
	330	35 × 35	360	900	420	4,2	2,8	1,4	-A337-M90
470	35 × 50	250	630	300	5,4	3,6	1,8	-A477-M90	
560	35 × 55	210	530	250	6,3	4,2	2,1	-A567-M90	
450	47	22 × 35	2300	5300	4300	1,1	0,72	0,36	-A5476-M
	47	25 × 30	2300	5300	4300	1,1	0,74	0,37	-J5476-M
	68	25 × 35	1600	3700	3100	1,4	0,94	0,47	-A5686-M
	100	30 × 35	1100	2500	2100	1,9	1,2	0,62	-A5107-M
	150	30 × 45	720	1700	1400	2,5	1,7	0,83	-A5157-M
	150	35 × 25	930	1700	1420	2,5	1,6	0,81	-A5157-M90
	220	35 × 40	880	1360	950	3,4	2,2	1,1	-A5227-M90
	330	35 × 50	590	900	630	4,0	2,7	1,3	-A5337-M90
500	15	22 × 25	5900	9900	8300	0,54	0,36	0,18	-A6156-M
	22	22 × 30	4000	6700	5600	0,70	0,46	0,23	-A6226-M
	33	22 × 35	2700	4500	3800	0,91	0,60	0,30	-A6336-M
	47	25 × 35	1900	3200	2700	1,2	0,78	0,39	-A6476-M
	68	25 × 45	1300	2200	1800	1,6	1,0	0,52	-A6686-M
	100	30 × 45	880	1500	1300	2,0	1,4	0,68	-A6107-M

1) 120 Hz conversion factor of ripple current:  $I_{- (120 Hz)} = 1,03 \cdot I_{- (100 Hz)}$

2) To obtain the required ordering code, prefix the type number to the short code. E. g.: B43503-G476-M

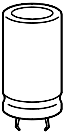

B 41 503  
B 43 503

Not for new design

**Useful life**

versus ambient temperature  $T_A$  under ripple current operating conditions <sup>1)</sup>

$U_R = 10 \dots 100 \text{ V-}$

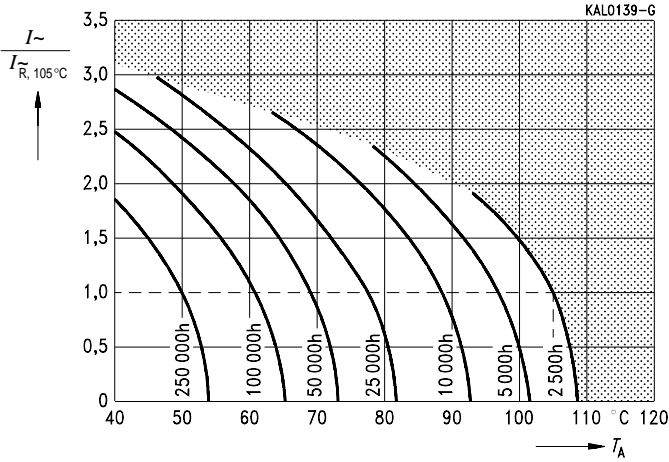

$U_R = 200 \dots 500 \text{ V-}$

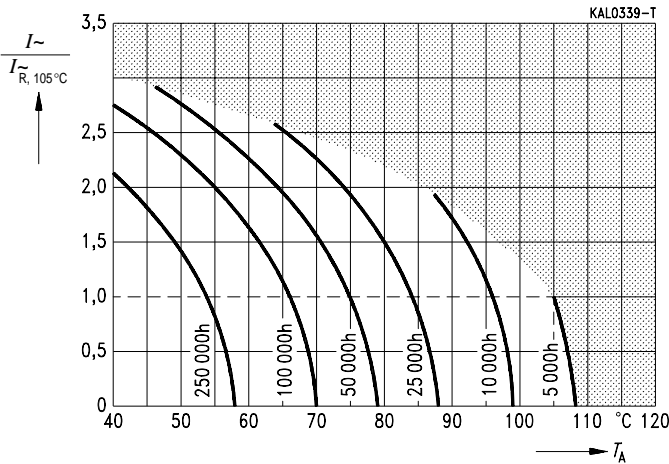

1) Refer to page 34 for an explanation on how to interpret the useful life graphs.

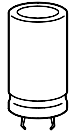

**Permissible ripple current  $I_r$**   
versus frequency  $f$

$U_R \leq 100 \text{ V-}$

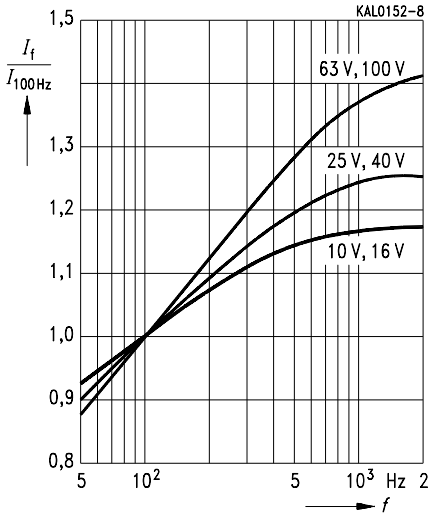

**Permissible ripple current  $I_r$**   
versus frequency  $f$

$U_R \geq 200 \text{ V-}$

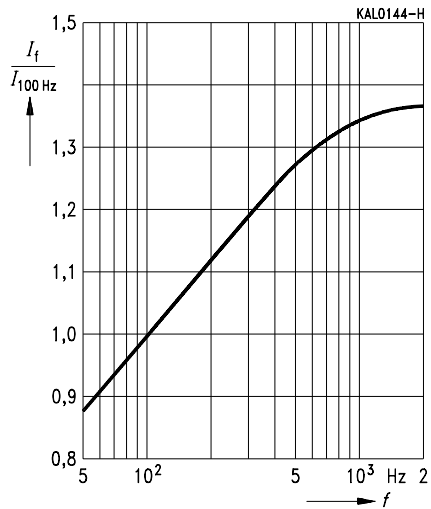

**Equivalent series resistance  $R_{ESR}$**   
versus frequency  $f$

Typical behavior

$U_R \leq 100 \text{ V-}$

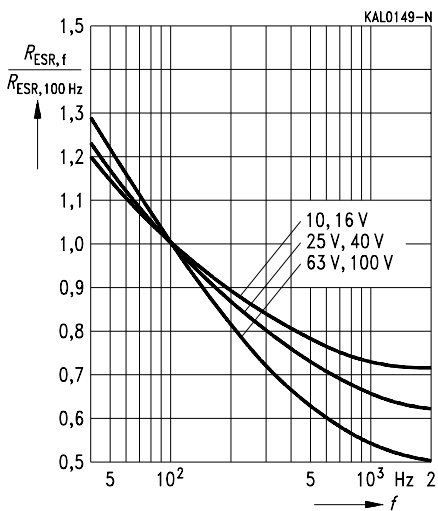

**Equivalent series resistance  $R_{ESR}$**   
versus frequency  $f$

Typical behavior

$U_R \geq 200 \text{ V-}$

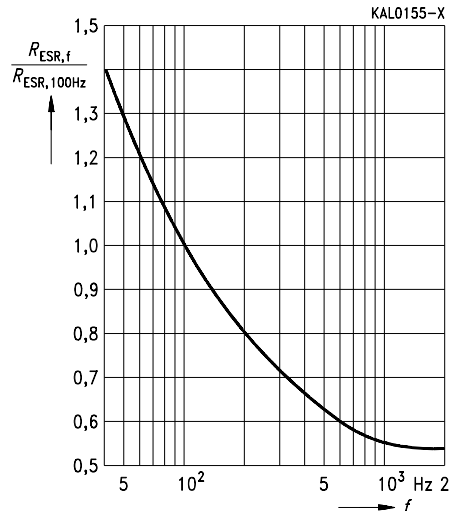

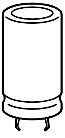

B 41 503  
B 43 503

Not for new design

**Impedance  $Z$**   
versus frequency  $f$   
Typical behavior  
 $U_R \leq 100 \text{ V}$

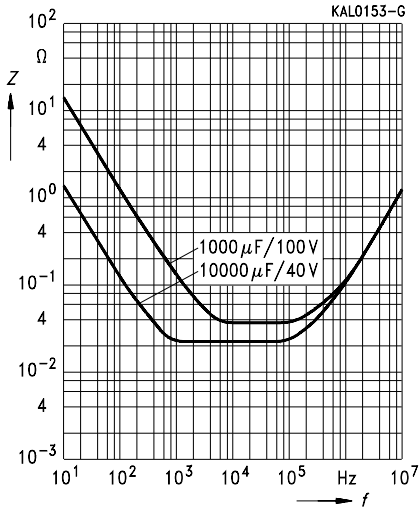

**Impedance  $Z$**   
versus frequency  $f$   
and temperature  $T$  for  $100 \mu\text{F} / 400 \text{ V}$ —  
Typical behavior

