

	DIN EN 61558-2-6	VDE	108266
	DIN EN 60 335-1	VDE	102961/84814
	UL 5085-3	UL	on request
	UL 5085-1	UL	E98173
	C22.2	CSA	on request

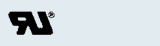
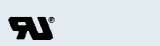

- according to REACH regulation
- according to RoHs regulation

- Output Power up to 15.0 VA
- Non short-circuit-proof at temperature class ta 70 °C/B
- Standard type cast housing “K” and “O”
- Excellent temperature fluctuation resistance properties
- High electrical safety and long service-life features
- High voltage resistance
- Self-extinguishing cast housing and sealing material
- Per item tested quality with certificate

Protection extern secondary by:

- Micro fuse according to IEC 127 or
- PTC resistance

Connection scheme (only connected pins are present)

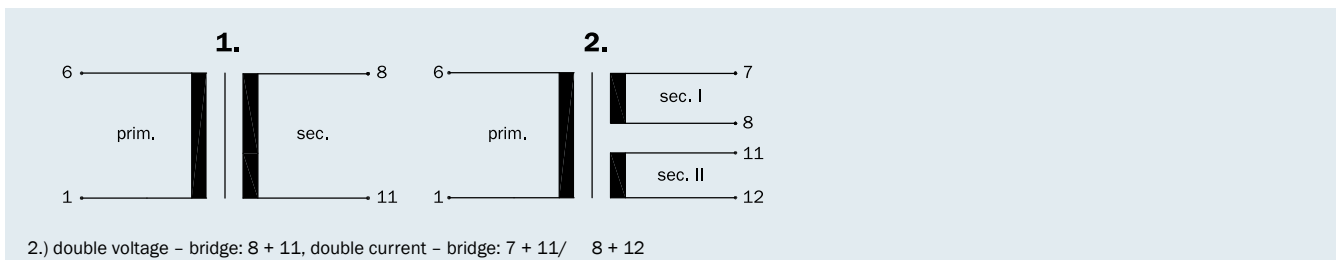

Frame size/Core height	Output power ta 70 °C/B	Height (h)	Weight	Packaging unit
BV EI 480 /12.5 mm*	7.0 VA	30.2 ± 0.5 mm	0.250 kg	20/16 pieces**
BV EI 481 /16.8 mm	10.0 VA	34.6 ± 0.5 mm	0.300 kg	20/16 pieces**
BV EI 482 /20.5 mm	12.0 VA	38.5 ± 0.5 mm	0.350 kg	20/16 pieces**
BV EI 483 /25.5 mm	15.0 VA	43.5 ± 0.5 mm	0.450 kg	20/16 pieces**

* only type cast housing 'O'

** it depends on kind of cast housing

Connecting pins type cast housing "0"

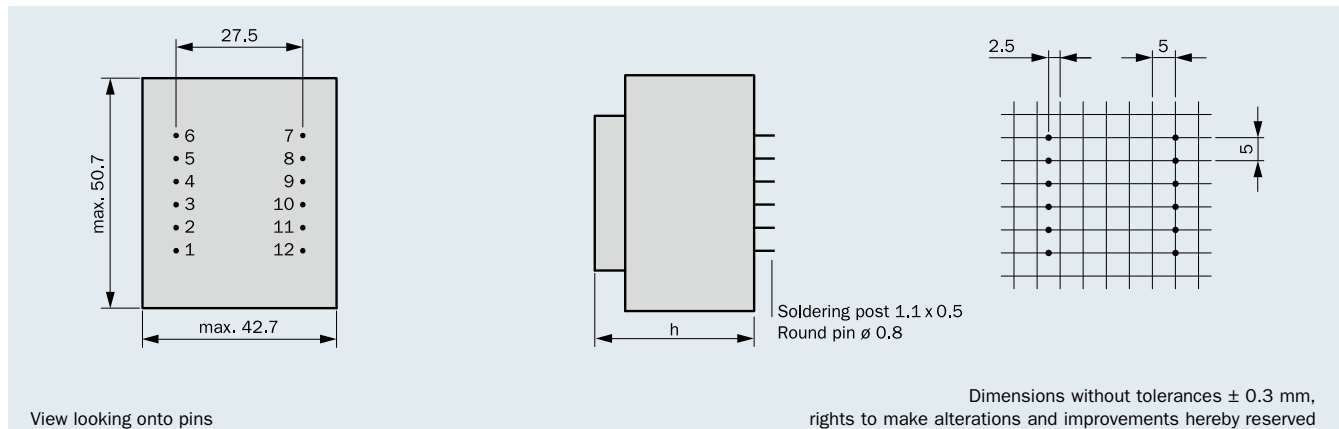

Type cast housing "0"

7.0 VA ta 70°C/B	Order No.	Primary voltage V	Connecting pins prim.	Secondary voltage V	Current sec. mA	Connecting pins sec.	No-load voltage V	Connection scheme
Frame size/Core height BV EI 480.... / 12.5 mm non short-circuit-proof  no load power loss type. 2.3 W	BV EI 480 1385	230	1-6	1 x 6	1167	8-11	1 x 7.9	1
	BV EI 480 1386	230	1-6	2 x 6	583	7-8/11-12	2 x 7.9	2
	BV EI 480 1387	230	1-6	1 x 7.5	933	8-11	1 x 9.8	1
	BV EI 480 1388	230	1-6	2 x 7.5	467	7-8/11-12	2 x 9.8	2
	BV EI 480 1389	230	1-6	1 x 9	788	8-11	1 x 11.8	1
	BV EI 480 1390	230	1-6	2 x 9	388	7-8/11-12	2 x 11.8	2
	BV EI 480 1391	230	1-6	1 x 12	583	8-11	1 x 15.8	1
	BV EI 480 1392	230	1-6	2 x 12	292	7-8/11-12	2 x 15.8	2
	BV EI 480 1393	230	1-6	1 x 15	467	8-11	1 x 19.5	1
	BV EI 480 1394	230	1-6	2 x 15	233	7-8/11-12	2 x 19.5	2
	BV EI 480 1395	230	1-6	1 x 18	389	8-11	1 x 23.3	1
	BV EI 480 1396	230	1-6	2 x 18	195	7-8/11-12	2 x 23.3	2
	BV EI 480 1397	230	1-6	1 x 21	333	8-11	1 x 27.5	1
	BV EI 480 1398	230	1-6	1 x 24	292	8-11	1 x 31.3	1

Type cast housing "0"

10.0 VA ta 70°C/B	Order No.	Primary voltage V	Connecting pins prim.	Secondary voltage V	Current sec. mA	Connecting pins sec.	No-load voltage V	Connection scheme
Frame size/Core height BV EI 481.... / 16.8 mm non short-circuit-proof  no load power loss type. 2.0 W	BV EI 481 1325	230	1-6	1 x 6	1667	8-11	1 x 7.6	1
	BV EI 481 1305	230	1-6	2 x 6	833	7-8/11-12	2 x 7.6	2
	BV EI 481 1312	230	1-6	1 x 7.5	1333	8-11	1 x 9.8	1
	BV EI 481 1326	230	1-6	2 x 7.5	667	7-8/11-12	2 x 9.8	2
	BV EI 481 1291	230	1-6	1 x 9	1111	8-11	1 x 11.5	1
	BV EI 481 1271	230	1-6	2 x 9	556	7-8/11-12	2 x 11.5	2
	BV EI 481 1295	230	1-6	1 x 12	834	8-11	1 x 15.5	1
	BV EI 481 1327	230	1-6	2 x 12	417	7-8/11-12	2 x 15.3	2
	BV EI 481 1323	230	1-6	1 x 15	667	8-11	1 x 18.6	1
	BV EI 481 1324	230	1-6	2 x 15	333	7-8/11-12	2 x 18.6	2
	BV EI 481 1307	230	1-6	1 x 18	556	8-11	1 x 22.3	1
	BV EI 481 1328	230	1-6	2 x 18	278	7-8/11-12	2 x 22.3	2
	BV EI 481 1381	230	1-6	1 x 21	477	8-11	1 x 25.1	1
	BV EI 481 1329	230	1-6	1 x 24	417	8-11	1 x 28.7	1

Connecting pins type cast housing "K" with 2 fixing straps

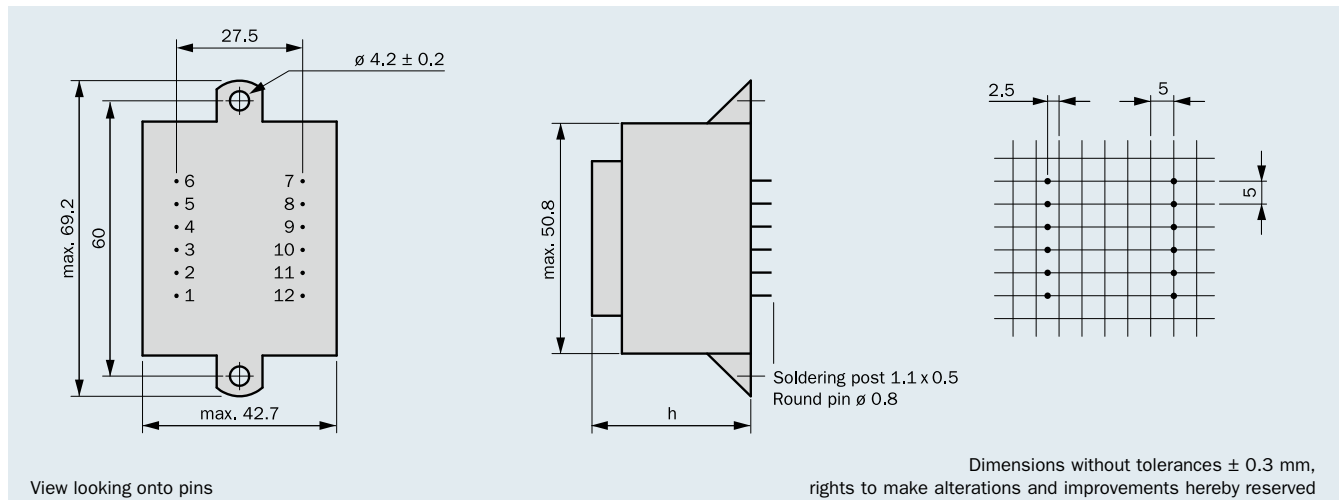

Type cast housing "K"

Order No.	Primary voltage V	Connecting pins prim.	Secondary voltage V	Current sec. mA	Connecting pins sec.	No-load voltage V	Connection scheme
BV EI 481 1142	230	1-6	1 x 6	1667	8-11	1 x 7.6	1
BV EI 481 1134	230	1-6	2 x 6	833	7-8/11-12	2 x 7.6	2
BV EI 481 1182	230	1-6	1 x 7.5	1333	8-11	1 x 9.8	1
BV EI 481 1188	230	1-6	2 x 7.5	667	7-8/11-12	2 x 9.8	2
BV EI 481 1167	230	1-6	1 x 9	1111	8-11	1 x 11.5	1
BV EI 481 1118	230	1-6	2 x 9	556	7-8/11-12	2 x 11.5	2
BV EI 481 1172	230	1-6	1 x 12	834	8-11	1 x 15.5	1
BV EI 481 1119	230	1-6	2 x 12	417	7-8/11-12	2 x 15.3	2
BV EI 481 1184	230	1-6	1 x 15	667	8-11	1 x 18.6	1
BV EI 481 1120	230	1-6	2 x 15	333	7-8/11-12	2 x 18.6	2
BV EI 481 1185	230	1-6	1 x 18	556	8-11	1 x 22.3	1
BV EI 481 1192	230	1-6	2 x 18	278	7-8/11-12	2 x 22.3	2
BV EI 481 1273	230	1-6	1 x 21	477	8-11	1 x 25.1	1
BV EI 481 1186	230	1-6	1 x 24	417	8-11	1 x 28.7	1

Type cast housing "K"

Order No.	Primary voltage V	Connecting pins prim.	Secondary voltage V	Current sec. mA	Connecting pins sec.	No-load voltage V	Connection scheme
BV EI 482 1231	230	1-6	1 x 6	2000	8-11	1 x 8.3	1
BV EI 482 1232	230	1-6	2 x 6	1000	7-8/11-12	2 x 8.3	2
BV EI 482 1233	230	1-6	1 x 7.5	1600	8-11	1 x 10.6	1
BV EI 482 1236	230	1-6	2 x 7.5	800	7-8/11-12	2 x 10.6	2
BV EI 482 1237	230	1-6	1 x 9	1333	8-11	1 x 12.4	1
BV EI 482 1238	230	1-6	2 x 9	667	7-8/11-12	2 x 12.4	2
BV EI 482 1239	230	1-6	1 x 12	1000	8-11	1 x 16.3	1
BV EI 482 1240	230	1-6	2 x 12	500	7-8/11-12	2 x 16.3	2
BV EI 482 1241	230	1-6	1 x 15	800	8-11	1 x 19.9	1
BV EI 482 1242	230	1-6	2 x 15	400	7-8/11-12	2 x 19.9	2
BV EI 482 1243	230	1-6	1 x 18	667	8-11	1 x 23.5	1
BV EI 482 1234	230	1-6	2 x 18	333	7-8/11-12	2 x 23.5	2
BV EI 482 1382	230	1-6	1 x 21	572	8-11	1 x 26.1	1
BV EI 482 1244	230	1-6	1 x 24	500	8-11	1 x 30.3	1

Type cast housing **“K”**

15.0 VA
ta 70 °C/B

Frame size/Core height
BV EI 483 /
25.5 mm





non short-circuit-proof



no load power loss
type. 2.5 W

Order No.	Primary voltage V	Connecting pins prim.	Secondary voltage V	Current sec. mA	Connecting pins sec.	No-load voltage V	Connection scheme
BV EI 483 1260	230	1-6	1 x 6	2500	8-11	1 x 7.8	1
BV EI 483 1257	230	1-6	2 x 6	1250	7-8/11-12	2 x 7.8	2
BV EI 483 1258	230	1-6	1 x 7.5	2000	8-11	1 x 9.5	1
BV EI 483 1245	230	1-6	2 x 7.5	1000	7-8/11-12	2 x 9.5	2
BV EI 483 1246	230	1-6	1 x 9	1667	8-11	1 x 12.0	1
BV EI 483 1247	230	1-6	2 x 9	833	7-8/11-12	2 x 12.0	2
BV EI 483 1248	230	1-6	1 x 12	1250	8-11	1 x 15.9	1
BV EI 483 1249	230	1-6	2 x 12	625	7-8/11-12	2 x 15.9	2
BV EI 483 1250	230	1-6	1 x 15	1000	8-11	1 x 19.1	1
BV EI 483 1251	230	1-6	2 x 15	500	7-8/11-12	2 x 19.1	2
BV EI 483 1252	230	1-6	1 x 18	833	8-11	1 x 22.8	1
BV EI 483 1259	230	1-6	2 x 18	417	7-8/11-12	2 x 22.8	2
BV EI 483 1302	230	1-6	1 x 21	714	8-11	1 x 26.0	1
BV EI 483 1253	230	1-6	1 x 24	625	8-11	1 x 30.6	1



	DIN EN 61558-2-6	VDE	on request
	DIN EN 60 335-1	VDE	102961/84814
	UL 5085-3	UL	on request
	UL 5085-1	UL	on request
	C22.2	CSA	on request

Individual version!

Parallel to the cataloged EI 48 series transformers, HAHN also produces other variants, e.g. with integrated thermo fuse or thermo switch, other housing, fixing- and connective options as well as non-encapsulated transformers.

- according to REACH regulation
- according to RoHs regulation

Type cast housing “0” with fixing band

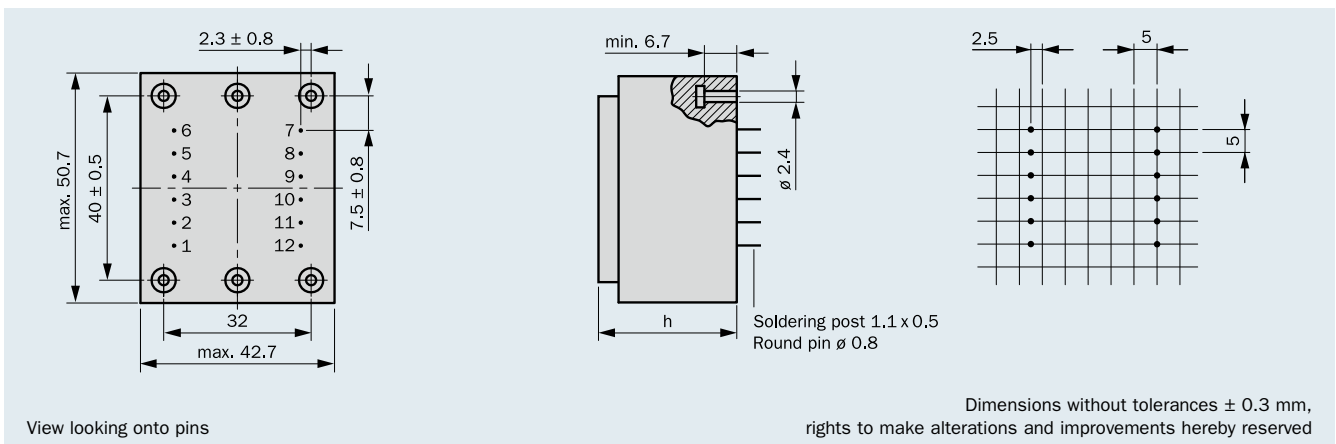

Type cast housing “SV” for upright mounting

