

# Autonics TEMPERATURE CONTROLLER TA SERIES INSTRUCTION MANUAL



Thank you for choosing our Autonics product.  
Please read the following safety considerations before use.

## ■ Safety Considerations

※Please observe all safety considerations for safe and proper product operation to avoid hazards.

※Safety considerations are categorized as follows.

**Warning** Failure to follow these instructions may result in serious injury or death.

**Caution** Failure to follow these instructions may result in personal injury or product damage.

※The symbols used on the product and instruction manual represent the following

▲ symbol represents caution due to special circumstances in which hazards may occur.

## ▲ Warning

- Fail-safe device must be installed when using the unit with machinery that may cause serious injury or substantial economic loss.** (e.g. nuclear power control, medical equipment, ships, vehicles, railways, aircraft, combustion apparatus, safety equipment, crime/disaster prevention devices, etc.) Failure to follow this instruction may result in fire, personal injury, or economic loss.
- Install on a device panel to use.** Failure to follow this instruction may result in electric shock or fire.
- Do not connect, repair, or inspect the unit while connected to a power source.** Failure to follow this instruction may result in electric shock or fire.
- Check 'Connections' before wiring.** Failure to follow this instruction may result in fire.
- Do not disassemble or modify the unit.** Failure to follow this instruction may result in electric shock or fire.

## ▲ Caution

- When connecting the power input and relay output, use AWG 20(0.50mm<sup>2</sup>) cable or over and tighten the terminal screw with a tightening torque of 0.74-0.90N·m.** When connecting the sensor input and communication cable without dedicated cable, use AWG 28-16 cable and tighten the terminal screw with a tightening torque of 0.74-0.90N·m. Failure to follow this instruction may result in fire or malfunction due to contact failure.
- Use the unit within the rated specifications.** Failure to follow this instruction may result in fire or product damage.
- Use dry cloth to clean the unit, and do not use water or organic solvent.** Failure to follow this instruction may result in fire or explosion.
- Do not use the unit in the place where flammable/explosive/corrosive gas, humidity, direct sunlight, radiant heat, vibration, impact, or salinity may be present.** Failure to follow this instruction may result in fire or explosion.
- Keep metal chip, dust, and wire residue from flowing into the unit.** Failure to follow this instruction may result in fire or product damage.

## ■ Ordering Information

TA	S	B	4	R	P	4	C
Unit							
C Celsius (°C)							
F Fahrenheit (°F)							
Temperature range for each sensor							
0	-50 to 100	-58 to 212	DPT	-	-	-	-
1	0 to 100	32 to 212	DPT	-	-	K (CA)	-
2	0 to 200	32 to 392	DPT	J (IC)	K (CA)	-	-
3	0 to 300	32 to 572	-	J (IC)	-	-	-
4	0 to 400	32 to 752	DPT	J (IC)	K (CA)	-	-
6	0 to 600	32 to 1,112	-	-	-	K (CA)	-
8	0 to 800	32 to 1,472	-	-	-	K (CA)	-
C	0 to 1,200	32 to 2,192	-	-	-	K (CA)	-
Sensor input type							
P	DPT100Ω						
J	J (IC)						
K	K (CA)						
Control output							
R	Relay output						
S	SSR drive output						
Power supply							
4	100-240VAC 50/60Hz						
Control method							
B	ON/OFF control & PID control combined						
Size							
S	DIN W48 × H48mm (8 pin plug type) <sup>※1</sup>						
M	DIN W72 × H72mm						
L	DIN W72 × H72mm						
Item							
TA	Analog setting type temperature controller						

※1: Socket (PG-08, PS-08 (N)) is sold separately.

※The above specifications are subject to change and some models may be discontinued without notice.  
※Be sure to follow cautions written in the instruction manual and the technical descriptions (catalog, homepage).

## ■ Specification

Series	TAS	TAM	TAL
Power supply	100-240VAC~ 50/60Hz		
Allowable voltage range	90 to 110% of rated voltage		
Power consumption	Max. 4VA		
Size	DIN W48 × H48mm	DIN W72 × H72mm	DIN W96 × H96mm
Display method	Deviation LED (red, green), Output LED (red)		
Setting type	Dial setting		
Setting accuracy	F.S. ±2% (room temperature 23°C ±5°C) <sup>※1</sup>		
Input type	RTD Thermocouples K (CA), J (IC)		
Control	ON/OFF Control Hysteresis: 2°C Fixed		
PID Control	Control period: Relay output 20 sec/SSR drive output 2 sec		
Control output	Relay 250VAC~ 3A 1c SSR Max. 12VDC±2V 20mA		
Functions	PV deviation indication, Error indication		
Sampling period	100ms		
Dielectric strength	2,000VAC 50/60Hz for 1 minute (between input terminal and power terminal)		
Vibration	0.75mm amplitude at frequency of 5 to 55Hz in each X, Y, Z direction for 2 hours		
Relay life cycle	Mechanical	Min. 10,000,000 operation (18,000 times/hr)	
	Electrical	Min. 100,000 operation (900 times/hr)	
Insulation resistance	Min. 100MΩ (at 500VDC megger)		
Noise strength	Square shaped noise by noise simulator (pulse width 1μs) ±2kV R-phase and S-phase		
Memory retention	Approx. 10 years (when using non-volatile semiconductor memory type)		
Environ -ment	Ambient temperature	-10 to 50°C, Storage: -20 to 60°C	
	Ambient humidity	35 to 85%RH, Storage: 35 to 85%RH	
Insulation type	Double insulation or reinforced insulation (mark: □, dielectric strength between the measuring input part and the power part: 2kV)		
Approval	CE, UL, etc.		
Weight <sup>※2</sup>	Approx. 107g (approx. 69g)	Approx. 171g (approx. 109g)	Approx. 232g (approx. 147g)

※1: <at room temperature range> Below 100 °C model is F.S. ±3%  
<out of room temperature range> Below 100°C model is F.S. ±4%, Over 100°C model is F.S. ±3%  
※2: The weight includes packaging. The weight in parentheses is for unit only.  
※Environment resistance is rated at no freezing or condensation.

## ■ Front Panel Identification

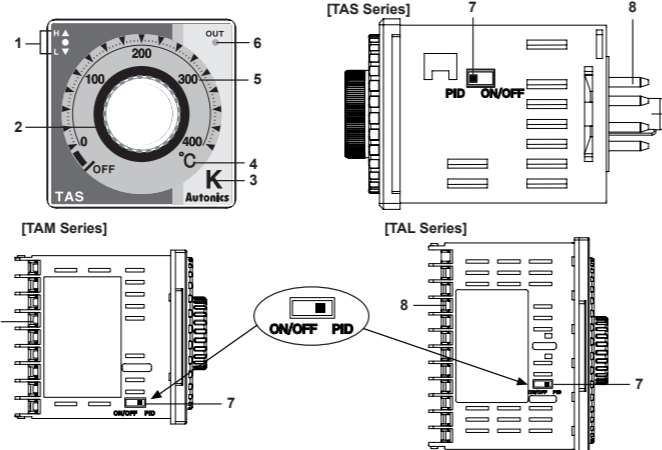

### 1. Deviation indicator

It shows deviation of present temperature (PV) based on set temperature (SV) by LED.

PV deviation temperature	Input deviation indicator [Deviation indicator: ● (green), ▲/▼ (red)]
Input sensor OPEN	▲ + ● + ▼ indicators flash (every 0.5 sec)
Exceed max. input value	▲ indicator flashes (every 0.5 sec)
More than 10°C	▲ indicator turns ON
More than 2°C to less than or equal to 10°C	▲ + ● indicators turn ON
Less than or equal to ±2°C	● indicator turns ON
More than -2°C to less than or equal to -10°C	● + ▼ indicators turn ON
More than -10°C	▼ indicator turns ON
Less than min. input value	▼ indicator flashes (every 0.5 sec)

※This is the same as Fahrenheit (°F).

**When power is on, all indicators light for 2 sec, then they turn off and control operation starts.**  
2. **Set temperature (SV) dial**  
Dial to change set temperature (SV). When changing set temperature, it is applied after 2 sec for the stable input.  
3. **Input sensor**  
Indicates sensor type of present value. Input sensor type or input range each product is shown in the below table.

Input Sensor	Range No.	Input range (°C)	Input range (°F)	
Thermo-couple	K (CA)	1	0 to 100	32 to 212
		2	0 to 200	32 to 392
		4	0 to 400	32 to 752
		6	0 to 600	32 to 1,112
	J (IC)	8	0 to 800	32 to 1,472
		C	0 to 1,200	32 to 2,192
		2	0 to 200	32 to 392
		3	0 to 300	32 to 572
RTD	DPT100Ω	4	0 to 400	32 to 752
		0	-50 to 100	-58 to 212
		1	0 to 100	32 to 212
		2	0 to 200	32 to 392
4	0 to 400	32 to 752		

※Set temperature within input range each sensor.

- Temperature unit**  
Indicates temperature unit (°C, °F) of set temperature (SV) and present value (PV).
- Temperature range**  
Indicates temperature range of set temperature (SV)
- Control output indicator**  
Turns ON when control output (Relay Output/SSR Output)
- Control mode selection switch**  
Select PID control (front part) or ON/OFF control (rear part) using switch. When changing the control method, turn off the power first and change the switch setting.
- Terminal block**  
Terminals for external connections. For more information, refer to '■ Connections'.

## ■ Dimensions

### 1. TAS Series

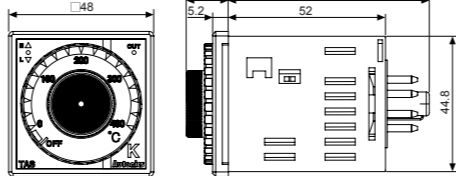

### 2. TAM Series

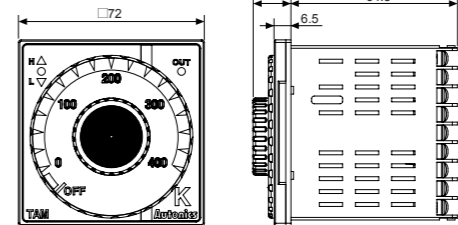

### 3. TAL Series

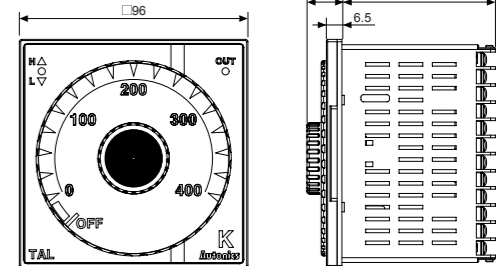

### ● Bracket

#### ● TAS Series

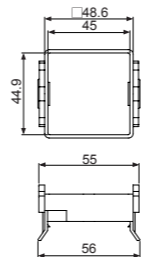

#### ● TAM, TAL Series

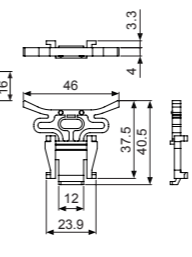

### ● Terminal cover (sold separately)

#### ● RMA-COVER (72×72mm)

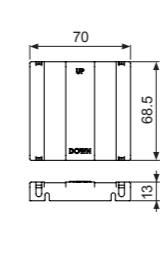

#### ● RLA-COVER (96×96mm)

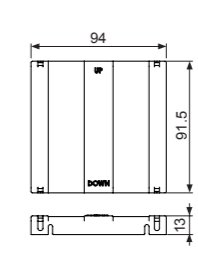

### ● Panel cut-out

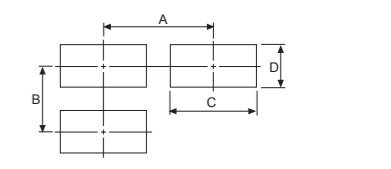

Series	Size	A	B	C	D
TAS	Min. 65	Min. 65	45 <sup>+0.6</sup> <sub>-0.6</sub>	45 <sup>+0.6</sup> <sub>-0.6</sub>	
TAM	Min. 90	Min. 90	68 <sup>+0.7</sup> <sub>-0.7</sub>	68 <sup>+0.7</sup> <sub>-0.7</sub>	
TAL	Min. 115	Min. 115	92 <sup>+0.8</sup> <sub>-0.8</sub>	92 <sup>+0.8</sup> <sub>-0.8</sub>	

## ■ Functions

### 1. SSR drive output

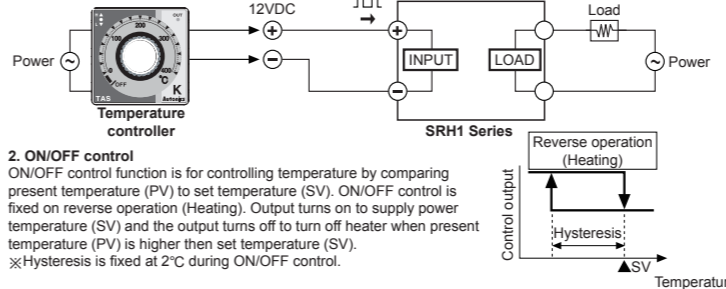

### 2. ON/OFF control

ON/OFF control function is for controlling temperature by comparing present temperature (PV) to set temperature (SV). ON/OFF control is fixed on reverse operation (Heating). Output turns on to supply power temperature (SV) and the output turns off to turn off heater when present temperature (PV) is higher than set temperature (SV).  
※Hysteresis is fixed at 2°C during ON/OFF control.

## ■ Connections

※RTD (Platinum resistance thermometer): DPT100Ω (3-wire) ※T.C. (Thermocouple): K (CA), J (IC)  
※Socket (PG-08, PS-08(N)) is sold separately.

### 1. TAS Series

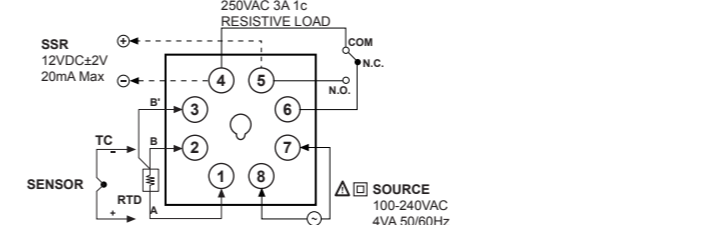

### 2. TAM Series

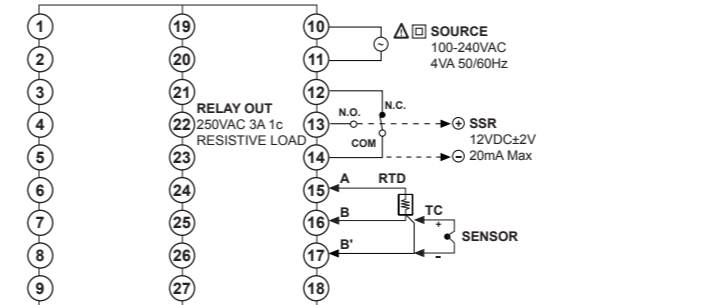

### 3. TAL Series

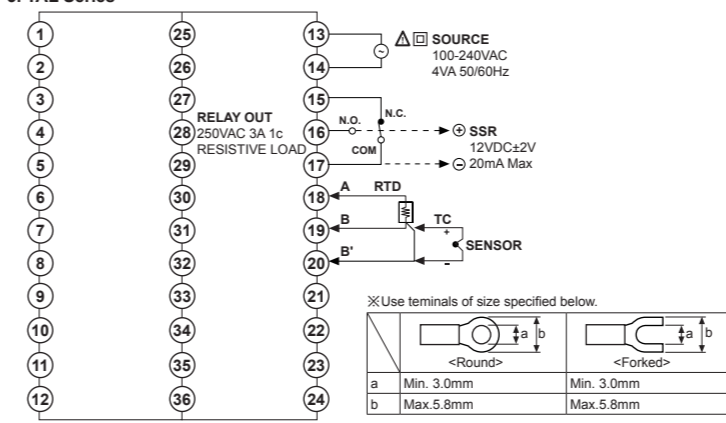

**3. PID Control**  
PID constants are suggested and implemented based on self tuning from supply power until reaching set temperature (SV), then self tuning is over after reaching set temperature (SV). When power supply, in case that set temperature (SV) dial points at OFF or self tuning can not be started because present temperature (PV) is higher than set temperature (SV) or hunting occurs during self tuning, output control is switched to proportion band (P) because that is considered to error. At that time, proportion band is fixed at 10°C.  
※Control cycle of PID control and proportion control is 20 sec in relay output model and 2 sec in SSR drive output model.

### 4. STOP

Control output could stop without power off by setting the front setting volume to below min. setting range. If control output stops by STOP function, green indicator in deviation indicator (●) will flash every 1 sec.

### 5. Error

Error mark will flash (every 1 sec) in PV indicator when error occurs during the control operation. It will operate normally, if input sensor is connected or temperature is returned to normal range.

No	Display	Description
1	▲ + ● + ▼ indicators flash	If input sensor is broken or sensor is not connected.
2	▲ indicator flashes	If measured sensor input is higher than temperature range.
3	▼ indicator flashes	If measured sensor input is lower than temperature range.

## ■ Installation

### 1. TAS Series

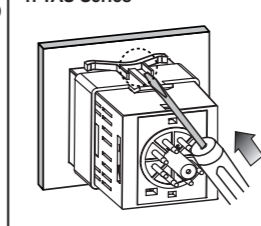

### 2. TAM, TAL Series

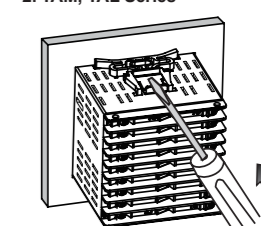

※Mount the product on the panel and securely push the bracket in using a tool, as shown in the diagram.

## ■ Cautions during Use

- Follow instructions in 'Cautions during Use'. Otherwise, It may cause unexpected accidents.
- Check the polarity of the terminals before wiring the temperature sensor.  
For RTD temperature sensor, wire it as 3-wire type, using cables in same thickness and length.  
For thermocouple (CT) temperature sensor, use the designated compensation wire for extending wire.
- Keep away from high voltage lines or power lines to prevent inductive noise.  
In case installing power line and input signal line closely, use line filter or varistor at power line and shielded wire at input signal line.  
Do not use near the equipment which generates strong magnetic force or high frequency noise.
- Install a power switch or circuit breaker in the easily accessible place for supplying or disconnecting the power.
- Do not use the unit for other purpose (e.g. voltmeter, ammeter), but temperature controller.
- Make a required space around the unit for radiation of heat.  
For accurate temperature measurement, warm up the unit over 20 min after turning on the power.
- Make sure that power supply voltage reaches to the rated voltage within 2 sec after supplying power.
- Do not wire to terminals which are not used.
- This unit may be used in the following environments.  
①Indoors (in the environment condition rated in 'Specifications')  
②Altitude max. 2,000m  
③Pollution degree 2  
④Installation category II

## ■ Major Products

- Photoelectric Sensors
- Fiber Optic Sensors
- Door Sensors
- Door Side Sensors
- Area Sensors
- Proximity Sensors
- Pressure Sensors
- Rotary Encoders
- Connector/Sockets
- Switching Mode Power Supplies
- Control Switches/Lamps/Buzzers
- I/O Terminal Blocks & Cables
- Stepper Motors/Drivers/Motion Controllers
- Graphic Logic Panels
- Field Network Devices
- Laser Marking System (Fiber, Co. Nd: YAG)
- Laser Welding/Cutting System
- Temperature Controllers
- Temperature/Humidity Transducers
- SSRs/Power Controllers
- Counters
- Timers
- Panel Meters
- Tachometer/Pulse (Rate) Meters
- Display Units
- Sensor Controllers

**Autonics Corporation**  
http://www.autonics.com

HEADQUARTERS:  
18, Bansong-ro 513beon-gil, Haundae-gu, Busan,  
South Korea, 48002  
TEL: 82-51-519-3232  
E-mail: sales@autonics.com