

2J3704M

CELLULAR Magnetic Mount

Key Features

CELLULAR

- 824-960 MHz

- 1710-2170 MHz

Magnetic Mount

Low Profile

Ground Plane Dependent

Customizable Cable and Connector

Dimensions 30.9 x 71.5 mm



1. Antenna and electrical specifications

Parameters	CELLULAR Antenna	
Standards	2G and 3G	
Band (MHz)	850/900	1700/1800/1900/2100
Frequency (MHz)	824-960	1710-2170
Return Loss (dB)	~-12.7	~-10.8
VSWR	~1.6:1	~1.8:1
Efficiency (%)	~49	~28
Peak Gain (dBi)	~1.7	~0.3
Average Gain (dB)	~-3.2	~-5.6
Impedance (Ohm)	50	
Polarisation	Linear	
Radiation Pattern	Omni-Directional	
Max. Input Power (W)	25	
Connector Type	Most RF Connectors (SMA-Male Standard)	
Cable Length	Any Cable Length (300cm Standard)	
Cable Type	Other Cables Available (RG174 Standard)	

Antenna Measurement Conditions:

Mounted on 30 x 30 cm Ground Plane
 200 cm RG174 Cable Length
 Measured in Certified CTIA 3D Anechoic Chamber

2. Mechanical and environmental specifications

Specifications	2J3704M
Mounting Type	Magnetic Mount
Dimensions (mm)	30.9 × 71.5
Radome	PC/ABS UV Stable
Radome color	Black
Operating Temperature (C)	-40 to +85
Storage Temperature (C)	-40 to +85
Substance Compliance	RoHS

3. Antenna parameters

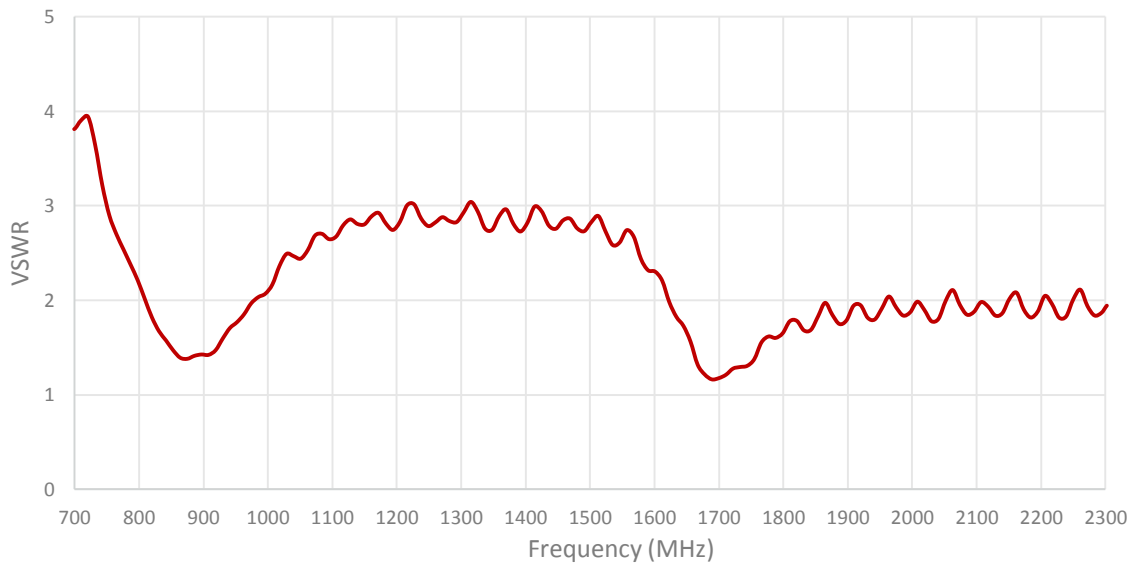
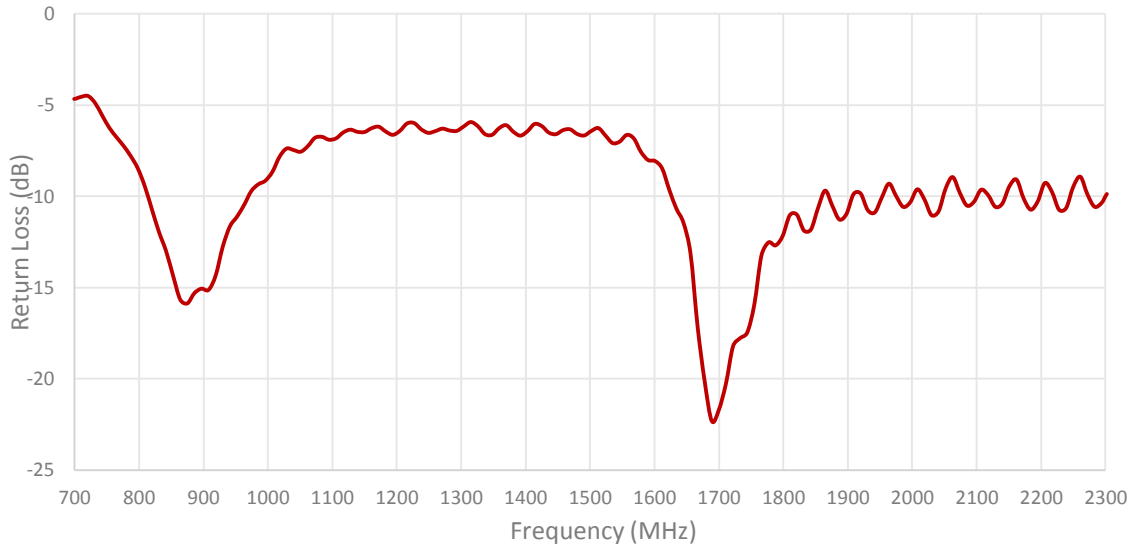

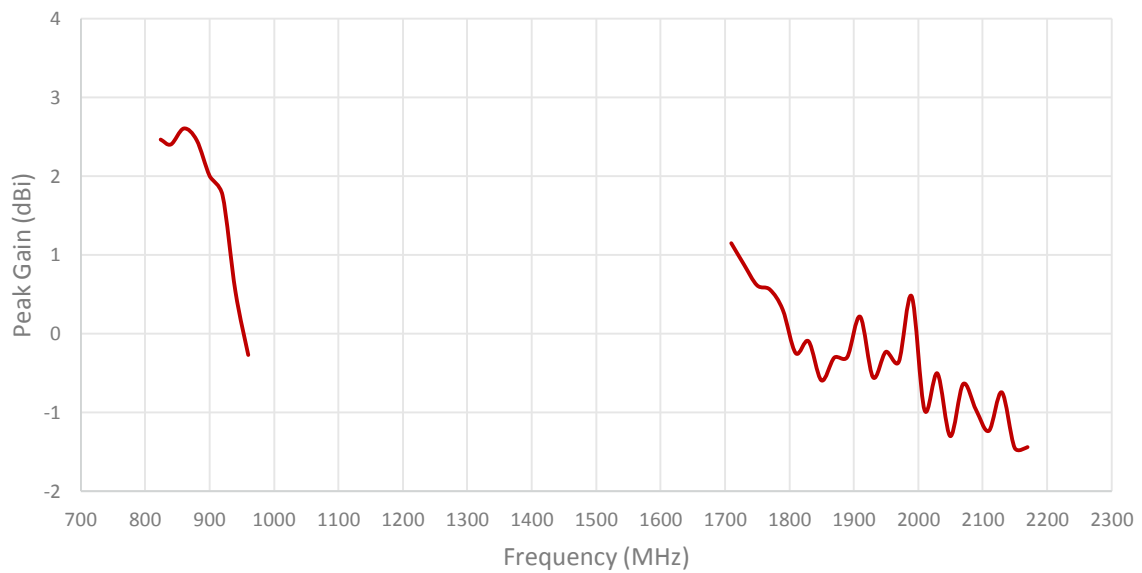
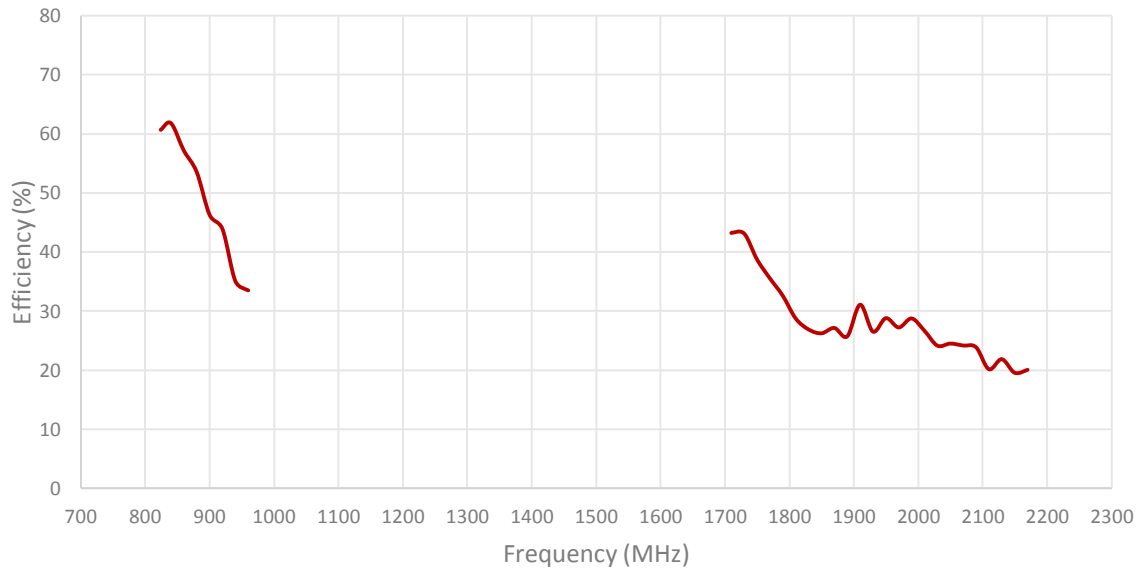

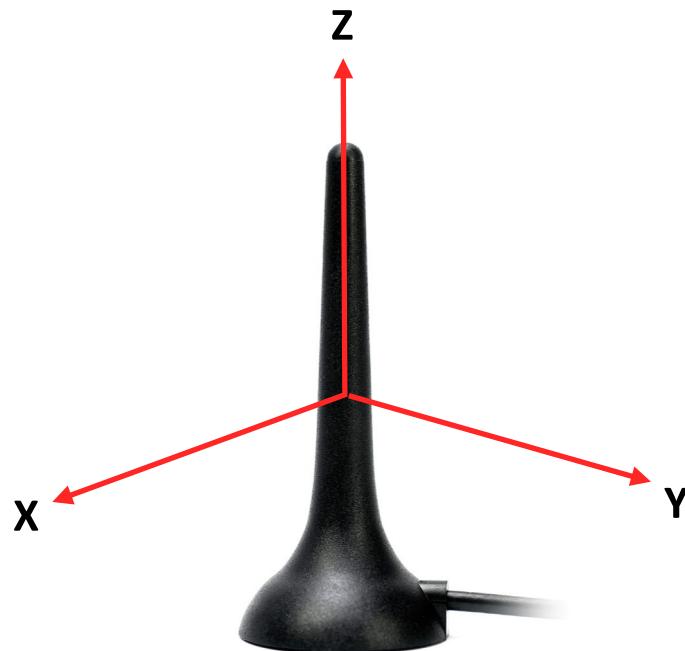
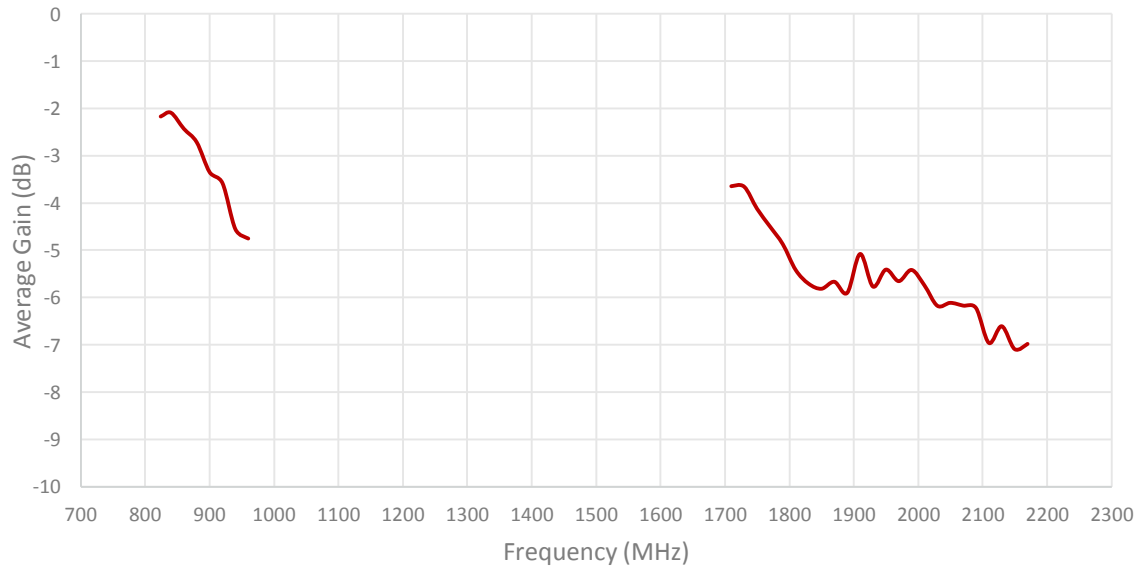

Radiation pattern reference

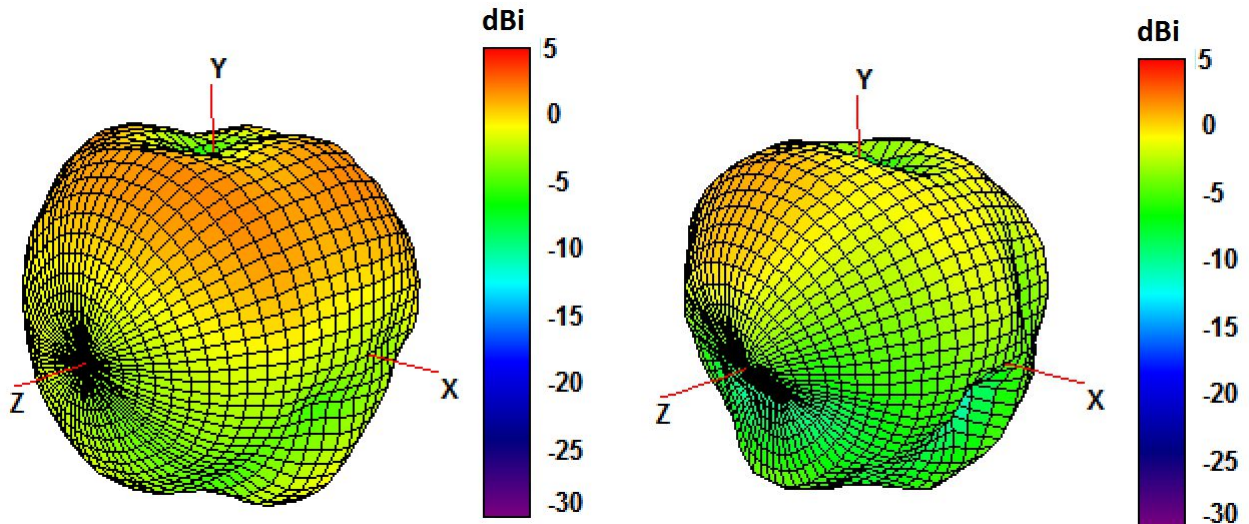

850 and 940 MHz Radiation pattern

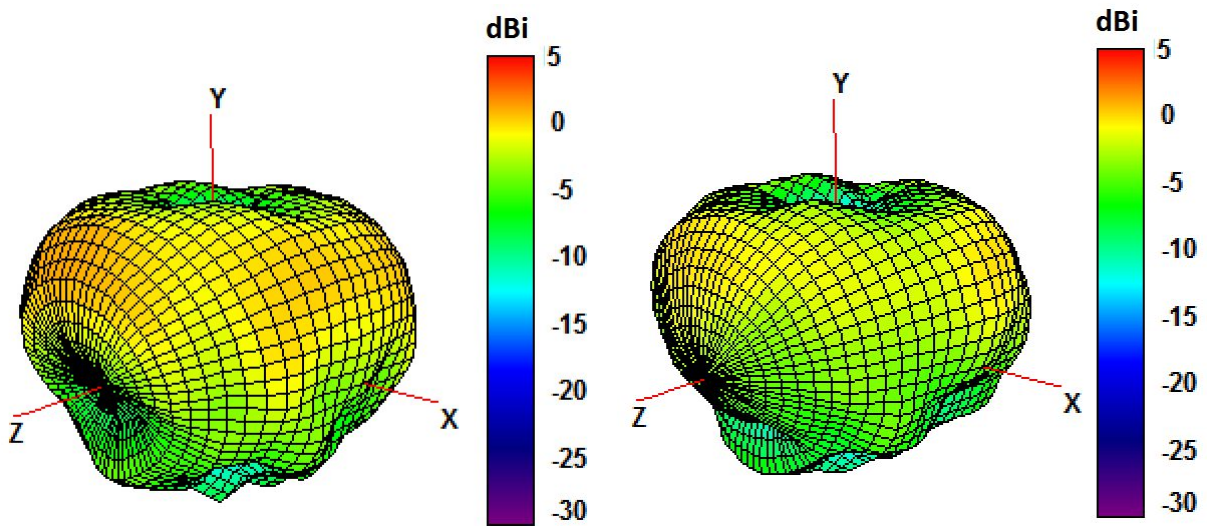

1750 and 1850 MHz Radiation pattern

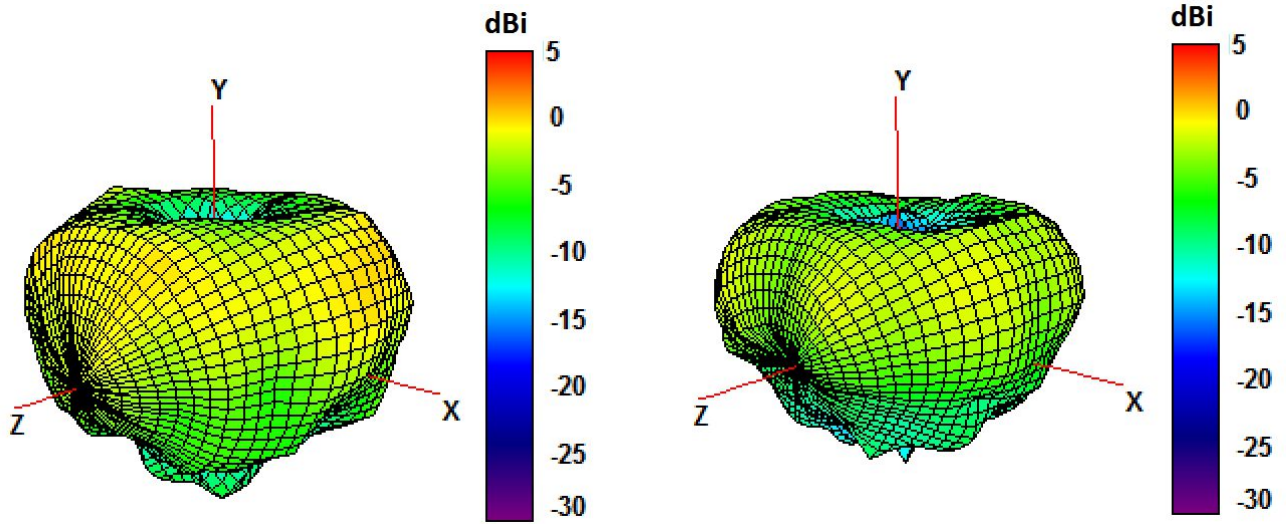

1950 and 2100 MHz Radiation pattern

4. Antenna drawings

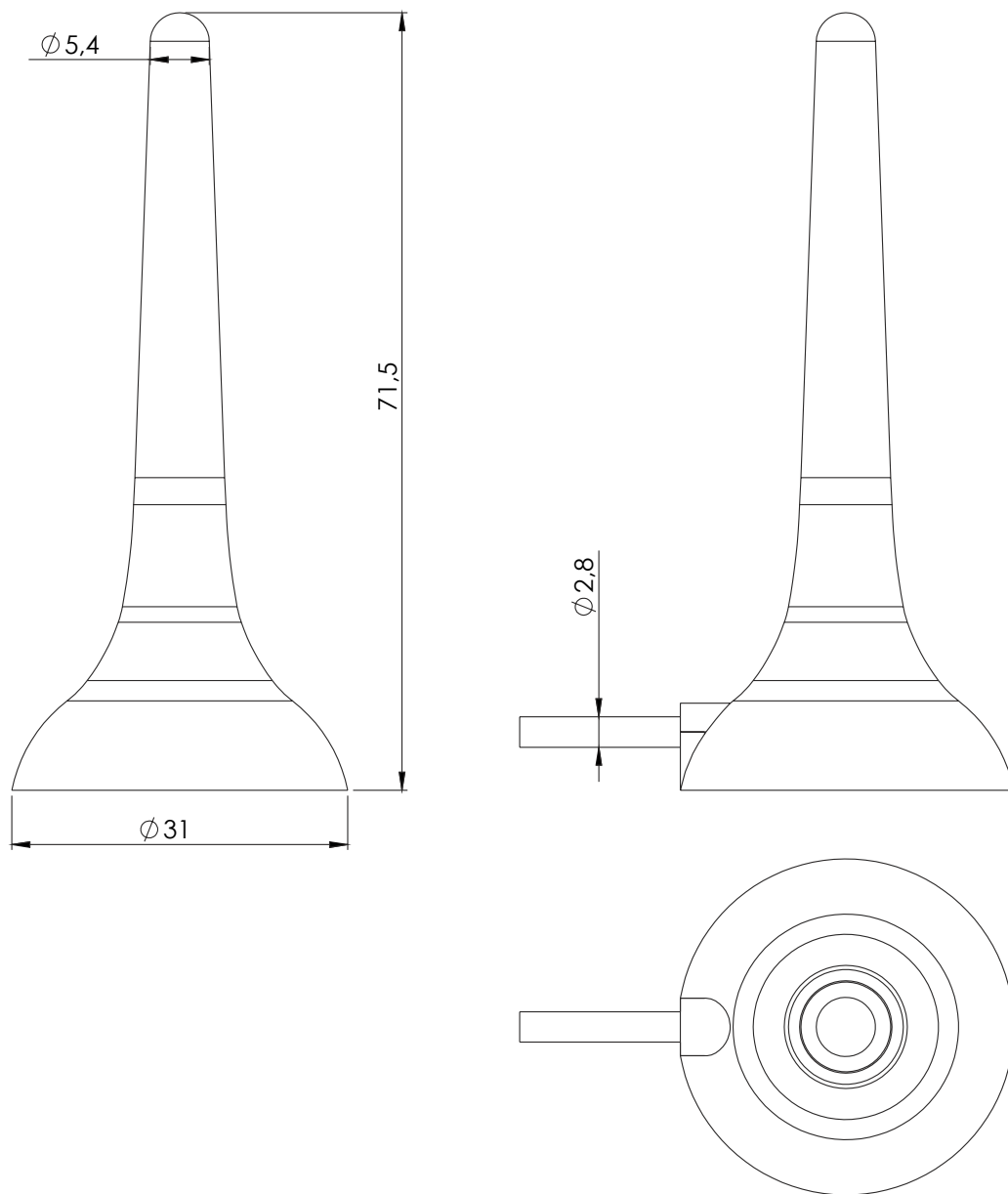

5. Antenna Images

