

# R13-278

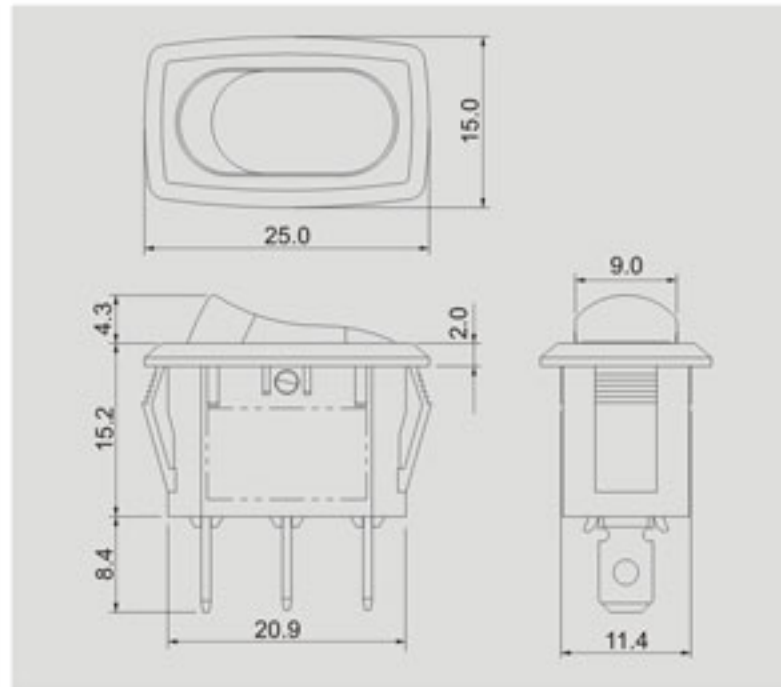

<b>Rating</b>
16A 125V AC 1/2HP 10A 250V AC 1/2HP
<b>Contact resistance</b>
50mΩ Max
<b>Insulation resistance</b>
DC 500V 100MΩ Min
<b>Dielectric strength</b>
AC 1500V 1 minute
<b>Cut-out</b>

	X	Y
	X	Y
0.75-1.25	23.0+0.1	11.6+0.1
1.25-2	23.3+0.1	11.6+0.1
2-3	23.6+0.1	11.6+0.1

3 mm max  
Cut-out for X8 ROCKER

	X	Y
	X	Y
0.75-1.5	23.3-0.1	11.6+0.1
1.50-2.5	23.6-0.1	11.6+0.1

## FEATURES

- \* MATERIAL: Frames are nylon (UL flame: 94V-2). Terminals are silver plated brass.
- \* Illuminated actuators are molded in PC, available with red, amber and green colors.
- \* Snap-in mounting, easy to install switch into panel.



## Ordering number instruction

R13-278 -

### FUNCTION

### TERMINAL

#### Illuminated button (帶燈)

#### Momentary / Illuminated button (彈回/帶燈)

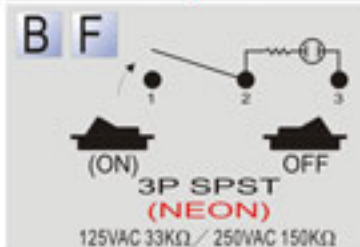

0 2		.187" SQ
0 9		PC N/A B,B8,BF,B8F
1 0		PC ANGLE N/A B,B8,BF,B8F
1 2		SO N/A B,B8,BF,B8F

#### Different position (動作特性不同)

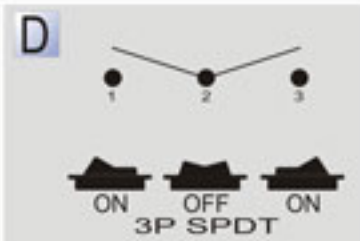
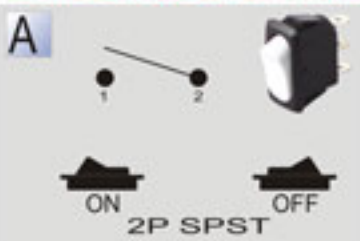

#### Momentary (彈回)

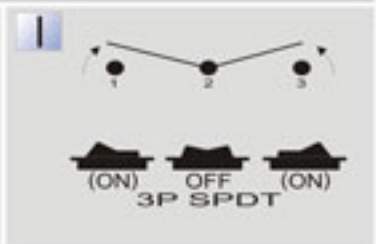
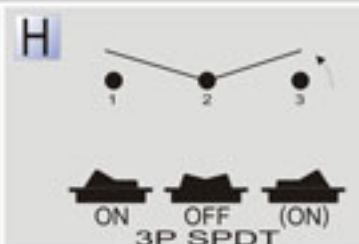
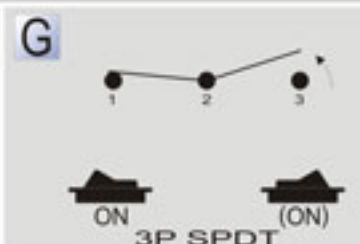
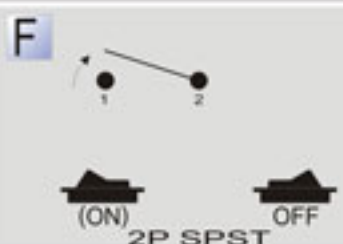
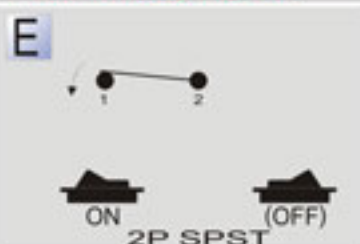

#### Waterproof (防水)

