

RK097 9mm Size Metal Shaft Multi-ganged Type

9.5mm width potentiometer ideal for various types of control



Typical Specifications



Items	Specifications
Total resistance tolerance	±20%
Maximum operating voltage	50V AC, 10V DC
Total rotational angle	300°±5° (For shaft movable type, 300° \pm $\frac{10}{5}$ °)
Rotational torque	2 to 25mN·m
Operating life	15,000 cycles
Operating temperature range	-20°C to +70°C -40°C to +85°C (Vehicle-compatible)

Product Line

Single-shaft without switch type

Number of resistor elements	Mounting direction	Shaft type	Length of the shaft L ₁ (mm)	Center detent	Total resistance (kΩ)	Resistance taper	Minimum order unit (pcs.)		Products No.	Drawing No.
							Japan	Export		
Single-unit	Horizontal type	Flat	15	Without	10	15A	1,200 (A type)	2,400 (A type)	RK097111080J	1
					20	1B			RK0971110909	
				With	10	15A			RK0971110D7F	
					50	1B			RK097111020N	
				Without	10	15A			RK097111080R	
					1B	RK0971110D88				
			20	Without	50	1B	RK09711100F8			
					15A	RK097111091M				
				With	10	1B	RK0971110D57			
					50	1B	RK09712100AV			
					20	20	RK0971210Z2M			
					25	20	RK0971210097			
Dual-unit for tone	Horizontal type	Flat	15	Without	15A	1,200 (A type)	2,400 (A type)	RK09712200MC	2	
					3B	1,200 (A type)	2,400 (A type)	RK09712200MY		
					15A	800 (B type)	1,600 (B type)	RK09712200HA		
					3B	800 (B type)	1,600 (B type)	RK097122008T		
					20	15A	800 (B type)	1,600 (B type)		RK09712200MT
					20	15A	800 (B type)	1,600 (B type)		RK09712200MT
Dual-unit for vol.	Horizontal type	Flat	20	Without	15A	1,200 (A type)	2,400 (A type)	RK09712200MC	2	
					3B	1,200 (A type)	2,400 (A type)	RK09712200MY		
					15A	800 (B type)	1,600 (B type)	RK09712200HA		
					3B	800 (B type)	1,600 (B type)	RK097122008T		
					20	15A	800 (B type)	1,600 (B type)		RK09712200MT
					20	15A	800 (B type)	1,600 (B type)		RK09712200MT

Notes

- Other varieties are also available. Refer to "Other Specifications" (P.316, 317).
- For automotive use, please contact us with detailed specifications.

Refer to P.316 for other specifications.
 Refer to P.318 for attached parts.
 Refer to P.320 for ordering products not listed.
 Refer to P.343 for soldering conditions.

Product Line

Single-shaft with rotary switch type

Number of resistor elements	Mounting direction	Shaft type	Length of the shaft L ₁ (mm)	Center detent	Total resistance (kΩ)	Resistance taper	Minimum order unit (pcs.)		Products No.	Drawing No.
							Japan	Export		
Single-unit	Horizontal type	Flat	15	Without	20	15A	700 (C type)	1,400 (C type)	RK0971111Z0P	3
					50					
			20		10	1B				
					15	3B				
Dual-unit for vol.		20	20					RK0971221Z05	4	
		20					RK0971221Z11			

Single-shaft push-on push-off (1.5mm travel) switch type

Number of resistor elements	Mounting direction	Shaft type	Length of the shaft L ₁ (mm)	Center detent	Total resistance (kΩ)	Resistance taper	Minimum order unit (pcs.)		Products No.	Drawing No.
							Japan	Export		
Single-unit	Horizontal type	Flat	25	Without	10	15A	700 (C type)	1,400 (C type)	RK097111202P	5
						1B				
Dual-unit for vol.			20		50	3B	600 (D type)	1,200 (D type)	RK097122200G	6

Single-shaft momentary push (0.5mm travel) switch type

Number of resistor elements	Mounting direction	Shaft type	Length of the shaft L ₁ (mm)	Center detent	Total resistance (kΩ)	Resistance taper	Minimum order unit (pcs.)		Products No.	Drawing No.
							Japan	Export		
Single-unit	Horizontal type	Flat	15	With	10	3B	700 (C type)	1,400 (C type)	RK0971114D0B	7
Dual-unit for tone			20	Without		1B			RK0971214Z06	8
Dual-unit for vol.						15A			RK0971224Z01	

Single-shaft momentary push (1.5mm travel) switch type

Number of resistor elements	Mounting direction	Shaft type	Length of the shaft L ₁ (mm)	Center detent	Total resistance (kΩ)	Resistance taper	Minimum order unit (pcs.)		Products No.	Drawing No.
							Japan	Export		
Single-unit	Horizontal type	Flat	20	Without	10	1B	700 (C type)	1,400 (C type)	RK0971114Z07	9

Notes

1. Other varieties are also available. Refer to "Other Specifications" (P.316, 317).
2. For automotive use, please contact us with detailed specifications.

Packing Specifications

Tray

Minimum order unit type	Number of packages (pcs.)		Export package measurements (mm)
	1 case /Japan	1 case /export packing	
A type	1,200	2,400	463×375×185
B type	800	1,600	540×373×207
C type	700	1,400	540×373×181
D type	600	1,200	540×373×225

Refer to P.316 for other specifications.
 Refer to P.318 for switch specifications.
 Refer to P.318 for attached parts.
 Refer to P.320 for ordering products not listed.
 Refer to P.343 for soldering conditions.

RK097 9mm Size Metal Shaft Multi-ganged Type

Product Line

Single-shaft with push-lock mechanism type

Number of resistor elements	Mounting direction	Shaft type	Length of the shaft L ₁ (mm)	Center detent	Total resistance (kΩ)	Resistance taper	Minimum order unit (pcs.)		Products No.	Drawing No.	
							Japan	Export			
Single-unit	Horizontal type	Flat	25	Without	10	1B	700 (C type)	1,400 (C type)	RK097111T065	10	
					100	15A					RK097111TZ17
				With	10	1B					
					100						RK097111TD44
Dual-unit for tone	Horizontal type	Flat	25	Without	10	15A	600 (D type)	1,200 (D type)	RK097121TD57	11	
Dual-unit for vol					50				3B		RK097122T017
								RK097122TZ0A			

Single-shaft with push-lock switch type

Number of resistor elements	Mounting direction	Shaft type	Length of the shaft L ₁ (mm)	Center detent	Total resistance (kΩ)	Resistance taper	Minimum order unit (pcs.)		Products No.	Drawing No.
							Japan	Export		
Single-unit	Horizontal type	Flat	25	Without	5	1B	700 (C type)	1,400 (C type)	RK097111U00S	12

Dual-shaft, dual-unit without switch type

Number of resistor elements	Mounting direction	Shaft	Shaft type	Length of the shaft L ₁ L ₂ (mm)	Center detent	Total resistance (kΩ)	Resistance taper	Minimum order unit (pcs.)		Products No.	Drawing No.	
								Japan	Export			
Dual-unit (Single-shaft, Single-unit)	Horizontal type	The outer shaft	Slotted	15	Without	10	15A	700 (C type)	1,400 (C type)	RK097221005C	13	
		The inner shaft	Flat	25								
		The outer shaft	Slotted	15			15C					RK097221004C
		The inner shaft	Flat	25								

Notes

1. Other varieties are also available. Refer to "Other Specifications" (P.316, 317).
2. For automotive use, please contact us with detailed specifications.

Packing Specifications

Tray

Minimum order unit type	Number of packages (pcs.)		Export package measurements (mm)
	1 case /Japan	1 case /export packing	
A type	1,200	2,400	463×375×185
B type	800	1,600	540×373×207
C type	700	1,400	540×373×181
D type	600	1,200	540×373×225

Refer to P.316 for other specifications.
 Refer to P.318 for switch specifications.
 Refer to P.318 for attached parts.
 Refer to P.320 for ordering products not listed.
 Refer to P.343 for soldering conditions.

■ Dimensions

Unit:mm

No.	Photo	Style	PC board mounting hole dimensions (Viewed from mounting side)												
1		<table border="1"> <tr> <td>L₁</td> <td>15</td> <td>20</td> <td>25</td> </tr> <tr> <td>L_B</td> <td>5</td> <td>7</td> <td>10</td> </tr> <tr> <td>ℓ</td> <td>7</td> <td>12</td> <td>12</td> </tr> </table> <p>Shaft shown in full CCW position</p>	L ₁	15	20	25	L _B	5	7	10	ℓ	7	12	12	
L ₁	15	20	25												
L _B	5	7	10												
ℓ	7	12	12												
2		<table border="1"> <tr> <td>L₁</td> <td>15</td> <td>20</td> <td>25</td> </tr> <tr> <td>L_B</td> <td>5</td> <td>7</td> <td>10</td> </tr> <tr> <td>ℓ</td> <td>7</td> <td>12</td> <td>12</td> </tr> </table> <p>Shaft shown in full CCW position</p>	L ₁	15	20	25	L _B	5	7	10	ℓ	7	12	12	
L ₁	15	20	25												
L _B	5	7	10												
ℓ	7	12	12												
3		<table border="1"> <tr> <td>L₁</td> <td>15</td> <td>20</td> </tr> <tr> <td>L_B</td> <td>5</td> <td>7</td> </tr> <tr> <td>ℓ</td> <td>7</td> <td>12</td> </tr> </table> <p>Shaft shown in full CCW position</p>	L ₁	15	20	L _B	5	7	ℓ	7	12				
L ₁	15	20													
L _B	5	7													
ℓ	7	12													
4		<table border="1"> <tr> <td>L₁</td> <td>15</td> <td>20</td> </tr> <tr> <td>L_B</td> <td>5</td> <td>7</td> </tr> <tr> <td>ℓ</td> <td>7</td> <td>12</td> </tr> </table> <p>Shaft shown in full CCW position</p>	L ₁	15	20	L _B	5	7	ℓ	7	12				
L ₁	15	20													
L _B	5	7													
ℓ	7	12													

Rotary Potentiometers
Slide Potentiometers

Metal Shaft

Insulated Shaft

Knob Operating







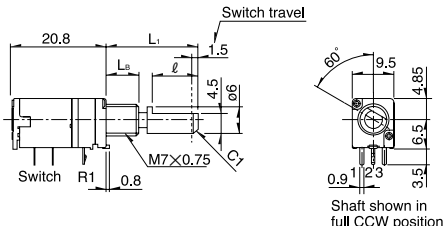
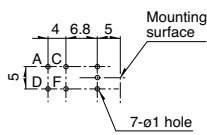

Through Shaft Type

Ring Type

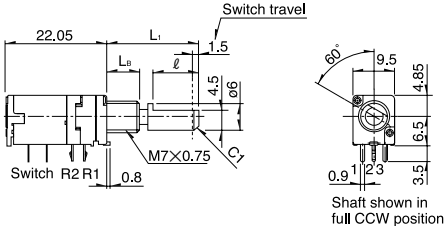
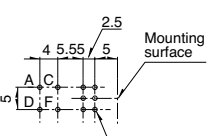
RK097 9mm Size Metal Shaft Multi-ganged Type

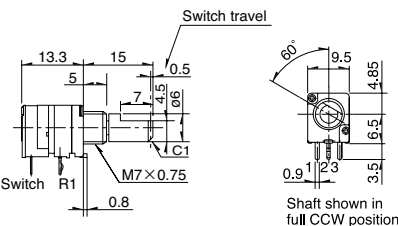
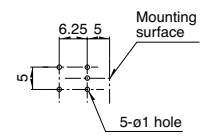

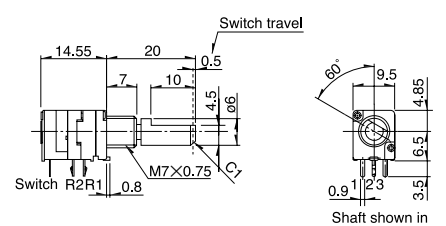
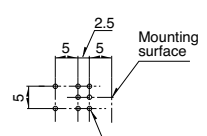



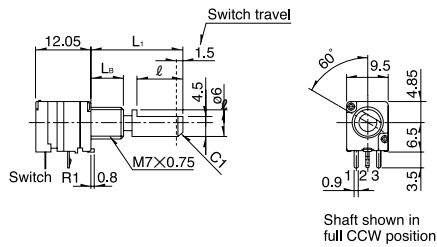
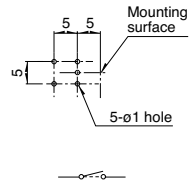

Dimensions

Unit:mm

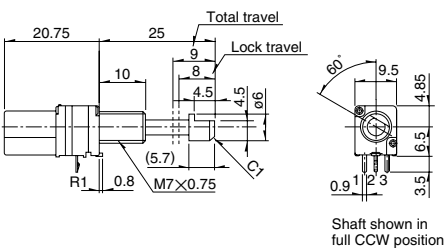
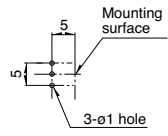
No.	Photo	Style	PC board mounting hole dimensions (Viewed from mounting side)						
5	 <p>Single-shaft, single-unit with push-on push-off switch RK0971112-5R2412</p>	<table border="1"> <tr><td>L_1</td><td>25</td></tr> <tr><td>L_B</td><td>10</td></tr> <tr><td>l</td><td>12</td></tr> </table> 	L_1	25	L_B	10	l	12	 
L_1	25								
L_B	10								
l	12								
6	 <p>Single-shaft, dual-unit with push-on push-off switch RK0971222-5R2412 (For vol.)</p>	<table border="1"> <tr><td>L_1</td><td>20</td></tr> <tr><td>L_B</td><td>7</td></tr> <tr><td>l</td><td>10</td></tr> </table> 	L_1	20	L_B	7	l	10	 
L_1	20								
L_B	7								
l	10								
7	 <p>Single-shaft, single-unit with momentary push switch travel 0.5mm RK0971114-5R4211</p>		 						
8	 <p>Single-shaft, dual-unit with momentary push switch travel 0.5mm RK0971214-5R4211 (For tone) RK0971224-5R4211 (For vol.)</p>		 						

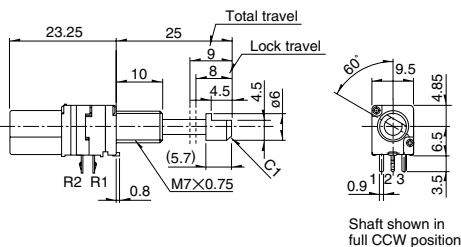
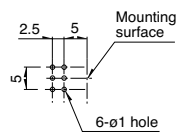
Dimensions

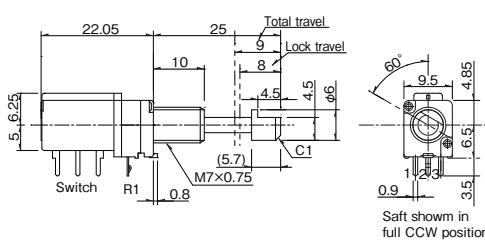
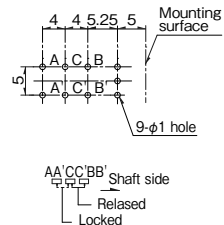
Unit:mm

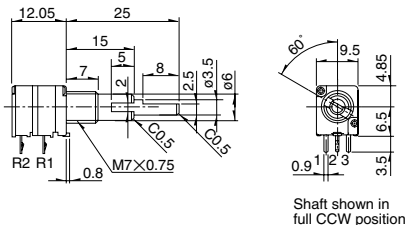
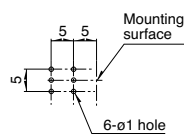
No.	Photo	Style	PC board mounting hole dimensions (Viewed from mounting side)						
9	<p>Single-shaft, single-unit with momentary push switch travel 1.5mm RK0971114-5R4611</p> 	<table border="1" style="margin-bottom: 10px;"> <tr> <td>L_1</td> <td>20</td> </tr> <tr> <td>L_B</td> <td>7</td> </tr> <tr> <td>ℓ</td> <td>10</td> </tr> </table>  <p>Shaft shown in full CCW position</p>	L_1	20	L_B	7	ℓ	10	
L_1	20								
L_B	7								
ℓ	10								
10	<p>Single-shaft, single-unit with push-lock mechanism RK097111T</p> 	 <p>Shaft shown in full CCW position</p>							
11	<p>Single-shaft, dual-unit with push-lock mechanism RK097121T (For tone) RK097122T (For vol.)</p> 	 <p>Shaft shown in full CCW position</p>							
12	<p>Single-shaft, single-unit with push-lock switch RK097111U-5R2522</p> 	 <p>Shaft shown in full CCW position</p>							
13	<p>Dual-shaft, dual-unit RK0972210</p> 	 <p>Shaft shown in full CCW position</p>							

Rotary Potentiometers
Slide Potentiometers

Metal Shaft

Insulated Shaft

Knob Operating

Through Shaft Type

Ring Type

9mm Size Metal Shaft Multi-ganged Type / Other Specifications

In addition to the products listed, we can accommodate the follow specifications.

Total Resistance Variety

Total resistance (kΩ)	5	10	20	50	100
-----------------------	---	----	----	----	-----

Resistance Taper

Resistance taper	15A	1B	3B	15C
------------------	-----	----	----	-----

Notes

Can be fitted with center-taps.

Dimensions of Terminal

Unit:mm

* Mounting height (H): 6.5mm (10mm and 12.5mm also available upon request.)
 * For single-unit type with tap is only available with H=6.5mm.
 * Tap is on the terminal 3 side only.

Dimensions of Bushings

Unit:mm

Bushing	M7	M9
Dimensions		
Applications	For single and dual-shaft	For dual-shaft only

Single-shaft Dimension

Flat type

Unit:mm

Style (Shaft diameter: $\phi 6$)

Shaft shown in full CCW position.

Detail dimensions

L_1	L_B	l
15	5	7
20	7	12 (10)
25	10	12
30	10	12

Models in parenthesis apply to those with a push-on switch and those with a push-on, push-off switch.

Note

Marked are specifications recommended by Alps Alpine.

Refer to P.320 for ordering products not listed.

9mm Size Metal Shaft Multi-ganged Type / Other Specifications

In addition to the products listed, we can accommodate the follow specifications.

Dimension of Dual-shaft Type

Flat type for inner shaft, slotted type for outer shaft

Unit:mm

Style (Inner-shaft: $\phi 6$ Outer-shaft: $\phi 8$)

L_1	L_2	L_B	l_1	l_2
20	10	5	8	4
25	15	7	8	5
30	20	10	8	5
35	25	10	8	5

Style (Inner-shaft: $\phi 3.5$ Outer-shaft: $\phi 6$)

L_1	L_2	L_B	l_1	l_2
20	10	5	8	4
25	15	7	8	5
30	20	10	8	5
35	25	10	8	5

Applications Both switchless and rotary switch models are available.

Shaft Dimensions of with Push-lock Mechanism/Switch

Unit:mm

$\ast L_1$	L_B	A	l
25	10	(5.7)	4.5
30	10	(10.7)	7
35	10	(15.7)	12

\ast Dimensions in unlocked state

Example of uses

Note

Marked are specifications recommended by Alps Alpine.

9mm Size Metal Shaft Multi-ganged Type / Switch Specifications

Switch type	Rotary switch	Push-on push-off switch	Momentary push switch		Push-lock switch	
	5R1211	5R2412	5R4211	5R4611	5R2522	
Contact arrangement	Single pole and single throw	Single pole and single throw	Single pole and single throw		Double pole and double throw	
Travel	50° max.	1.5±0.5mm	0.5 ^{+0.7} _{-0.3} mm	1.5±0.5mm	8±0.5mm	
Changeover force	50mN·m max.	12±8N	4 ⁺⁴ ₋₂ N	5±2N	8N max.	
Operating life under load	10,000 cycles			20,000 cycles	10,000 cycles	
Electrical performance	Rating	3A 16V DC (10mA 16V DC min. ratings)	3A 16V DC (10mA 16V DC min. ratings)	0.5A 12V DC (10mA 12V DC min. ratings)		0.3A 12V DC
	Contact resistance	100mΩ max. for initial period, 200mΩ max. after operating life.				
	Insulation resistance	100MΩ min. 250V DC				
	Voltage proof	300V AC for 1 minute				

9mm Size Metal Shaft Multi-ganged Type / Attached Parts

The following parts are included with the product.

Unit:mm

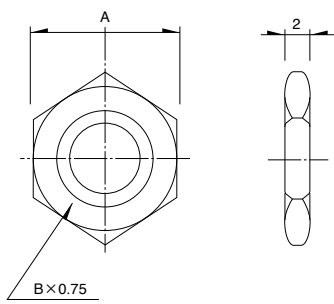
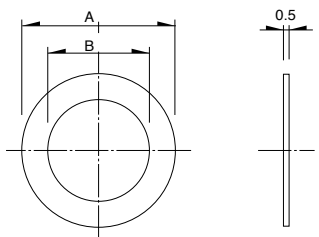
Nut			Washer		
					
Bearing screw diameter	Dimension		Bearing screw diameter	Dimension	
	A	B		A	B
M7	11	M7	φ12	φ7.2	
M9	11	M9	φ14	φ9.1	

9mm Size Metal Shaft Multi-ganged Type / Configuration Chart

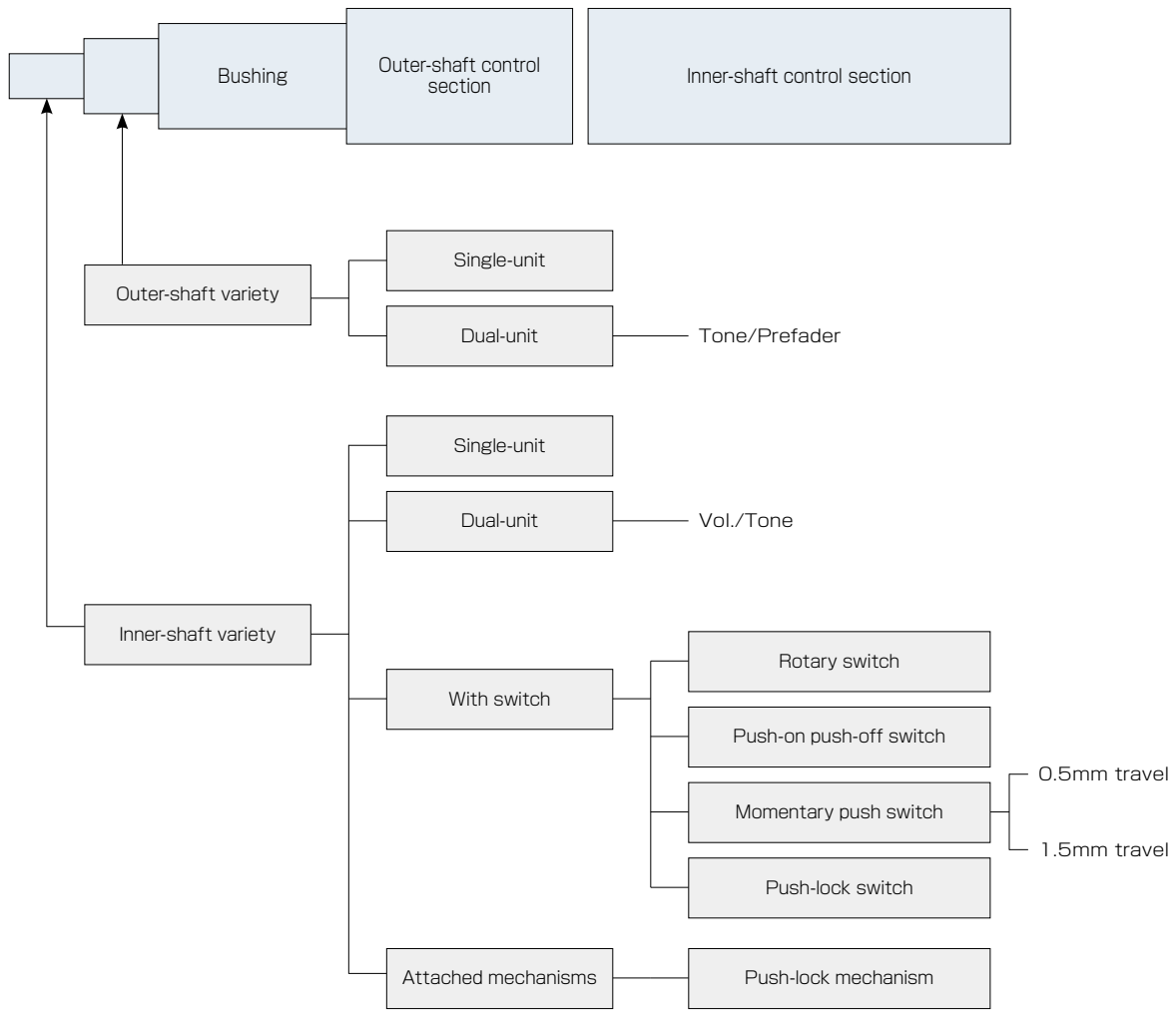

Note

The single-shaft type product lineups are the same as those in the inner-shaft variety.

- Rotary Potentiometers
- Slide Potentiometers
- Metal Shaft
- Insulated Shaft
- Knob Operating
- Through Shaft Type
- Ring Type

9mm Size Metal Shaft Multi-ganged Type / Ordering Products Not Listed

When ordering product varieties that are not listed, specify referring to the examples below.

Sample Part Number

R K 0 9 7 1 1 1 0 - **F 1 5** - **C 0** - **B 1 0 3**

Model type

Code	Model type
111	Single-shaft single-unit
121	Single-shaft dual-unit for tone
122	Single-shaft dual-unit for vol.

Switch specifications

Code	Switch specifications
0	Without switch
1	With rotary switch
2	With push-on push-off switch
4	With momentary push switch (0.5mm travel)
T	With push-lock mechanism
U	Push-lock switch

* Push on switch 1.5mm stroke is individually specified.

Shaft type

Code	Shaft type
F	Flat (shaft diameter : 6)

* Shaft diameter 3.5 is individually specified.

Length of the shaft L₁ (mm)

Code	Length of the shaft	Code	Length of the shaft
15	15	25	25
20	20	30	30

Detent

Code	Detent
C0	Without
C1	Center

* With rotary switch; for applications in types other than push-lock mechanism.

Resistance taper

Code	Resistance taper	Code	Resistance taper
A	15A	V	3B
B	1B	C	15C

* The resistance taper for rotary switches are individually defined.
 B: For tone & general (model type : 111, 121)
 V: For vol. (model type : 111, 122)

Total resistance

Code	Total resistance (kΩ)	Code	全抵抗値(kΩ)
502	5	503	50
103	10	104	100
203	20	—	—

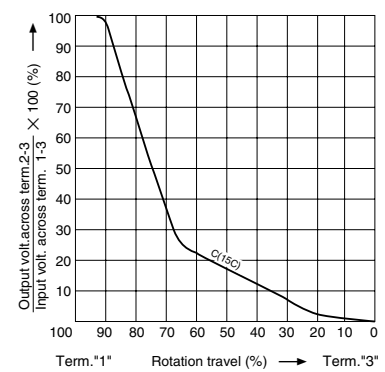
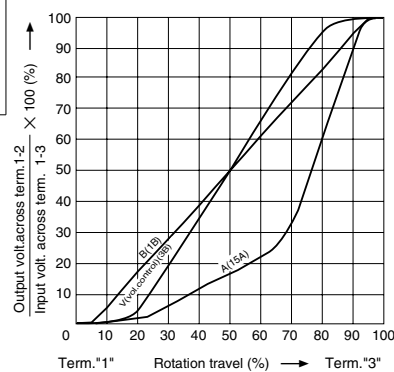









Notes

- Marked are specifications recommended by Alps Alpine.
- The above specification is only applicable to the one-shaft single-unit model and dual-unit ganged model.

Metal Shaft Potentiometers

List of Varieties

Type	9mm size			11mm size	
Series	RK09L	RK0971	RK0972	RK119	
	Single-shaft		Dual-shaft	Single-shaft	
Number of resistor elements	Single/dual		Dual	Single	
Photo					
Terminal mounting	Horizontal	Vertical	Horizontal		
Fixing method of bushing	Screw			Guide	
Operating temperature range	-10°C to +70°C		-20°C to +70°C -40°C to +85°C (Vehicle-compatible)		
Operating life	15,000 cycles				
Available for automotive use	—	—	○	○	
Life cycle (availability)					
Electrical performance	Total resistance (kΩ)	10, 20, 50, 100			10
	Resistance taper	15A, 1B, 3B, 15C			1B
	Rated Power	0.05W			
	Residual resistance	$R \leq 10k\Omega$ 20Ω max. $10k\Omega < R < 50k\Omega$ 30Ω max. $50k\Omega \leq R$ Nominal total resistance of 0.1% or less			$R \leq 10k\Omega$ 50Ω max.
	Maximum attenuation (Volume control)	$5k\Omega \leq R < 10k\Omega$ 70dB min. $10k\Omega \leq R < 50k\Omega$ 80dB min. $50k\Omega \leq R$ 90dB min.	$5k\Omega \leq R < 10k\Omega$ 70dB min. $10k\Omega \leq R < 50k\Omega$ 80dB min. $50k\Omega \leq R < 100k\Omega$ 90dB min. $100k\Omega \leq R$ 100dB min.	—	
	Gang error applicable to Dual-unit parts for audio volume control purposes	-40dB to 0dB 3dB max.			—
	Insulation resistance	100MΩ min. 250V DC			
	Voltage proof	300V AC for 1minute			300V AC for 1 minute or 360V for 2s
	Center-taps	Without	Without / With		Without
Mechanical performance	Detent	Without, Center			Without
	Stopper strength	0.5N·m	0.5N·m (With push-lock mechanism: 0.4N·m)		0.5N·m
	Push-pull strength	80N max.	100N max.		
	Vibration	10 to 55 to 10Hz/min., the amplitude is 1.5mm for all the frequencies, in the 3 direction of X, Y and Z and for 2 hours respectively			
Shaft style	Flat type		Inner-shaft: flat type Outer-shaft: slotted type	Flat type	
Terminal style	Insertion			Reflow	
Attached switch	—	—	Rotary switch Push-on push-off switch Push-on switch Push-lock switch	— Push-on switch	
Page	306		310		321

Metal Shaft Potentiometers Soldering Conditions	343
Potentiometers Cautions	418
Potentiometers Measurement and Test Methods	420
Potentiometers Resistance Taper	422

Notes

- For the switch attached, the single-shaft or inner shaft of the dual-shaft type can be chosen.
- The operating temperature range for automotive applications can be raised upon request. Please contact us for details.
- Indicates applicability to some products in the series.

Reference for Manual Soldering

Series	Tip temperature	Soldering time	No. of solders
RK09L, RK097	350°C max.	3s max.	1 time
RK203	300°C max.	3s max.	1 time
RK119	350±10°C	3 ⁺¹ ₀ s	1 time
RK271	350°C max.	5s max.	1 time
RK501	350±10°C	5 ⁺¹ ₀ s	1 time
RK163	350°C max.	5s max.	1 time
RK168	Potentiometer terminal	300°C max.	3s max.
	Motor terminal	350°C max.	2s max.

Reference for Dip Soldering

Series	Preheating		Dip soldering		No. of solders
	Soldering surface temperature	Heating time	Soldering temperature	Soldering time	
RK09L, RK097, RK203	100°C max.	2 min. max.	260±5°C	5±1s	2 time max.
RK501	120±10°C	2 min. max.	260±5°C	5±1s	2 time

Example of Reflow Soldering Condition

Temperature profile

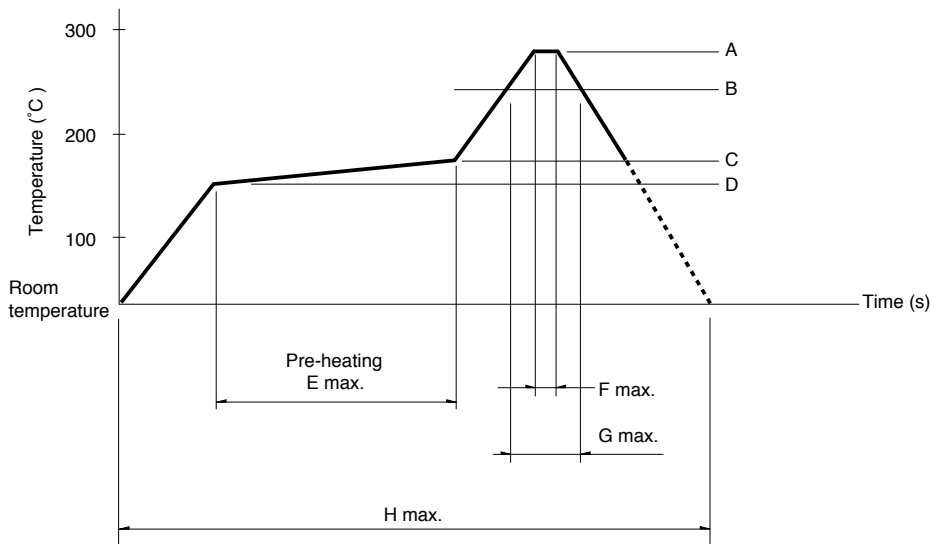

Series	A	B	C	D	E	F	G	H	No. of reflows
RK119	260°C	230°C	180°C	150°C	2 min.	3s	40s	4 min.	2 time max.

Notes

1. When using an infrared reflow oven, solder may sometimes not be applied. Be sure to use a hot air reflow oven or at type that uses infrared rays in combination with hot air.
2. The temperatures given above are the maximum temperatures at the terminals of the potentiometer when employing a hot air reflow method. The temperature of the PC board and the surface temperature of the potentiometer may vary greatly depending on the PC board material, its size and thickness. Ensure that the surface temperature of the potentiometer does not rise to 250°C or greater.
3. Conditions vary to some extent depending on the type of reflow bath used. Be sure to give due consideration to this prior to use.