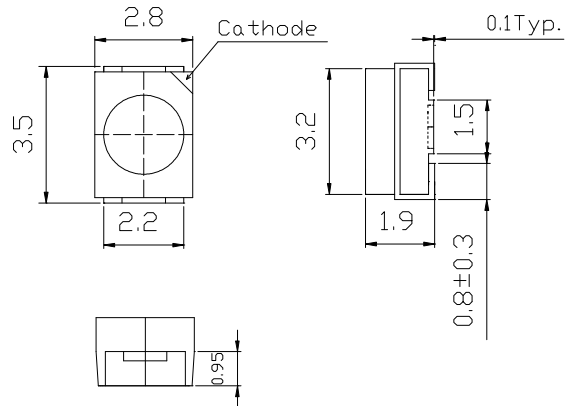

■Features

- High Power SMDs
- 3.5x2.8x1.9mm Standard Directivity
- Water Clear Type
- Superior Weather-resistance
- UV Resistant Epoxy

■Applications

- Automotive Dashboard Lighting
- Traffic Signal Lamp
- Back Lighting

■Outline Dimension

■Absolute Maximum Rating

(Ta=25°C)

Item	Symbol	Value	Unit
DC Forward Current	I_F	30	mA
Pulse Forward Current*	I_{FP}	100	mA
Reverse Voltage	V_R	5	V
Power Dissipation	P_D	120	mW
Operating Temperature	T_{opr}	-30 ~ +80	°C
Storage Temperature	T_{stg}	-30 ~ +100	°C
Lead Soldering Temperature	T_{sol}	260°C/3sec	-

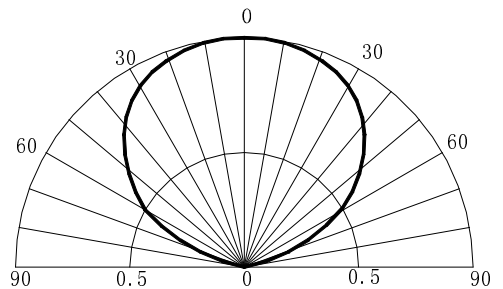
*Pulse width Max.10ms Duty ratio max 1/10

■Directivity

■Electrical -Optical Characteristics

(Ta=25°C)

Item	Symbol	Condition	Min.	Typ.	Max.	Unit
DC Forward Voltage	V_F	$I_F=20mA$	2.8	3.3	3.8	V
DC Reverse Current	I_R	$V_R=5V$	-	-	10	μA
Domi. Wavelength	λ_D	$I_F=20mA$	465	470	475	nm
Luminous Intensity	I_v	$I_F=20mA$	750	1120	1560	mcd
50% Power Angle	$2\theta_{1/2}$	$I_F=20mA$	-	120	-	deg