

## 600 V, 60 A very high speed trench gate field-stop IGBT

Datasheet - production data

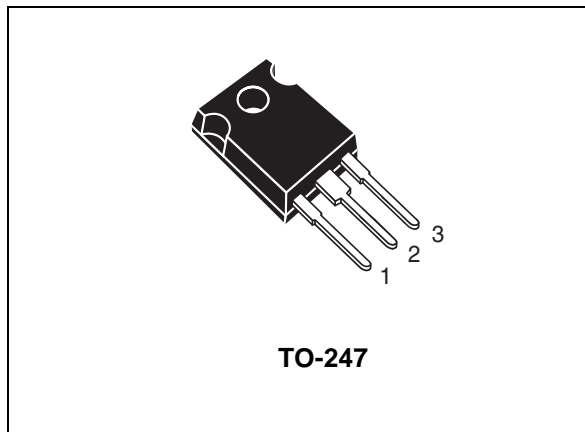
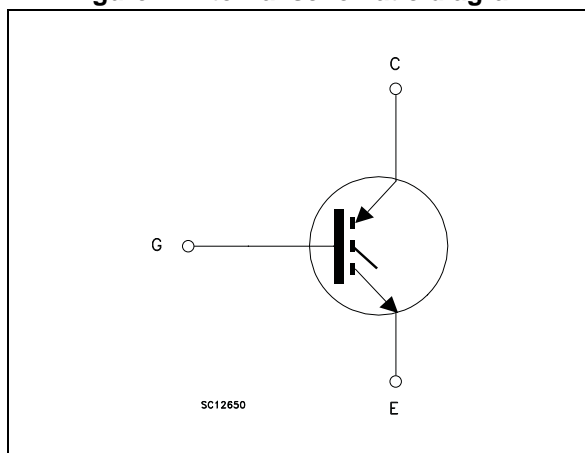

Figure 1. Internal schematic diagram



### Features

- Very high speed switching series
- Maximum junction temperature:  $T_J = 175\text{ }^\circ\text{C}$
- Tail-less switching off
- Low saturation voltage:  $V_{CE(sat)} = 1.85\text{ V (typ.)}$  @  $I_C = 60\text{ A}$
- Tight parameters distribution
- Safe paralleling
- Low thermal resistance
- Lead free package

### Applications

- Photovoltaic inverters
- Uninterruptible power supply
- Welding
- Power factor correction
- Very high frequency converters

### Description

This device is an IGBT developed using an advanced proprietary trench gate and field stop structure. The device is part of the "V" series of IGBTs, which represent an optimum compromise between conduction and switching losses to maximize the efficiency of very high frequency converters. Furthermore, a positive  $V_{CE(sat)}$  temperature coefficient and very tight parameter distribution result in safer paralleling operation.

Table 1. Device summary

Order code	Marking	Package	Packaging
STGW60V60F	GW60V60F	TO-247	Tube

# Contents

<b>1</b>	<b>Electrical ratings</b> .....	<b>3</b>
<b>2</b>	<b>Electrical characteristics</b> .....	<b>4</b>
	2.1 Electrical characteristics (curves) .....	6
<b>3</b>	<b>Test circuits</b> .....	<b>10</b>
<b>4</b>	<b>Package mechanical data</b> .....	<b>11</b>
<b>5</b>	<b>Revision history</b> .....	<b>13</b>

# 1 Electrical ratings

**Table 2. Absolute maximum ratings**

Symbol	Parameter	Value	Unit
$V_{CES}$	Collector-emitter voltage ( $V_{GE} = 0$ )	600	V
$I_C$	Continuous collector current at $T_C = 25\text{ °C}$	80 <sup>(1)</sup>	A
$I_C$	Continuous collector current at $T_C = 100\text{ °C}$	60	A
$I_{CP}$ <sup>(2)</sup>	Pulsed collector current	240	A
$V_{GE}$	Gate-emitter voltage	$\pm 20$	V
$P_{TOT}$	Total dissipation at $T_C = 25\text{ °C}$	375	W
$T_{STG}$	Storage temperature range	- 55 to 150	°C
$T_J$	Operating junction temperature	- 55 to 175	°C

1. Current level is limited by bond wires
2. Pulse width limited by maximum junction temperature and turn-off within RBSOA

**Table 3. Thermal data**

Symbol	Parameter	Value	Unit
$R_{thJC}$	Thermal resistance junction-case IGBT	0.4	°C/W
$R_{thJA}$	Thermal resistance junction-ambient	50	°C/W

## 2 Electrical characteristics

$T_J = 25\text{ °C}$  unless otherwise specified.

**Table 4. Static characteristics**

Symbol	Parameter	Test conditions	Min.	Typ.	Max.	Unit
$V_{(BR)CES}$	Collector-emitter breakdown voltage ( $V_{GE} = 0$ )	$I_C = 2\text{ mA}$	600			V
$V_{CE(sat)}$	Collector-emitter saturation voltage	$V_{GE} = 15\text{ V}, I_C = 60\text{ A}$		1.85	2.3	V
		$V_{GE} = 15\text{ V}, I_C = 60\text{ A}$ $T_J = 125\text{ °C}$		2.15		
		$V_{GE} = 15\text{ V}, I_C = 60\text{ A}$ $T_J = 175\text{ °C}$		2.35		
$V_{GE(th)}$	Gate threshold voltage	$V_{CE} = V_{GE}, I_C = 1\text{ mA}$	5.0	6.0	7.0	V
$I_{CES}$	Collector cut-off current ( $V_{GE} = 0$ )	$V_{CE} = 600\text{ V}$			25	$\mu\text{A}$
$I_{GES}$	Gate-emitter leakage current ( $V_{CE} = 0$ )	$V_{GE} = \pm 20\text{ V}$			250	nA

**Table 5. Dynamic characteristics**

Symbol	Parameter	Test conditions	Min.	Typ.	Max.	Unit
$C_{ies}$	Input capacitance	$V_{CE} = 25\text{ V}, f = 1\text{ MHz},$ $V_{GE} = 0$	-	8000	-	pF
$C_{oes}$	Output capacitance		-	280	-	pF
$C_{res}$	Reverse transfer capacitance		-	170	-	pF
$Q_g$	Total gate charge	$V_{CC} = 480\text{ V}, I_C = 60\text{ A},$ $V_{GE} = 15\text{ V},$ see <a href="#">Figure 23</a>	-	334	-	nC
$Q_{ge}$	Gate-emitter charge		-	130	-	nC
$Q_{gc}$	Gate-collector charge		-	58	-	nC

Table 6. IGBT switching characteristics (inductive load)

Symbol	Parameter	Test conditions	Min.	Typ.	Max.	Unit
$t_{d(on)}^{(1)}$	Turn-on delay time	$V_{CE} = 400\text{ V}$ , $I_C = 60\text{ A}$ , $R_G = 4.7\ \Omega$ , $V_{GE} = 15\text{ V}$ , see <a href="#">Figure 22</a>	-	60	-	ns
$t_r^{(1)}$	Current rise time		-	20	-	ns
$(di/dt)_{on}^{(1)}$	Turn-on current slope		-	2365	-	A/ $\mu$ s
$t_{d(off)}$	Turn-off delay time		-	208	-	ns
$t_f$	Current fall time		-	14	-	ns
$E_{on}^{(1)}$	Turn-on switching losses		-	0.75	-	mJ
$E_{off}^{(2)}$	Turn-off switching losses		-	0.55	-	mJ
$E_{ts}$	Total switching losses		-	1.3	-	mJ
$t_{d(on)}^{(1)}$	Turn-on delay time		$V_{CE} = 400\text{ V}$ , $I_C = 60\text{ A}$ , $R_G = 4.7\ \Omega$ , $V_{GE} = 15\text{ V}$ , $T_J = 175\text{ }^\circ\text{C}$ , see <a href="#">Figure 22</a>	-	57	-
$t_r^{(1)}$	Current rise time	-		23	-	ns
$(di/dt)_{on}^{(1)}$	Turn-on current slope	-		2191	-	A/ $\mu$ s
$t_{d(off)}$	Turn-off delay time	-		216	-	ns
$t_f$	Current fall time	-		27	-	ns
$E_{on}^{(1)}$	Turn-on switching losses	-		1.5	-	mJ
$E_{off}^{(2)}$	Turn-off switching losses	-		0.8	-	mJ
$E_{ts}$	Total switching losses	-		2.3	-	mJ

- Switching-on times and energy have been calculated applying the STGW60V60DF's co-pack diode in the high side of the test circuit in [Figure 22](#). Both IGBT and diode are at the same temperature. Energy losses include reverse recovery of the diode.
- Turn-off losses include also the tail of the collector current.

## 2.1 Electrical characteristics (curves)

Figure 2. Power dissipation vs. case temperature

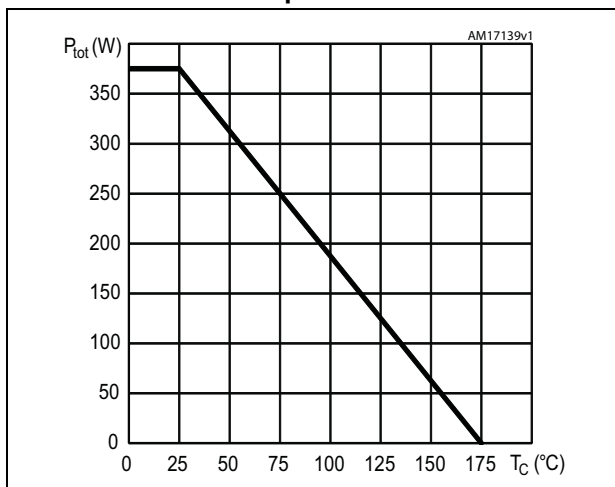

Figure 3. Collector current vs. temperature case

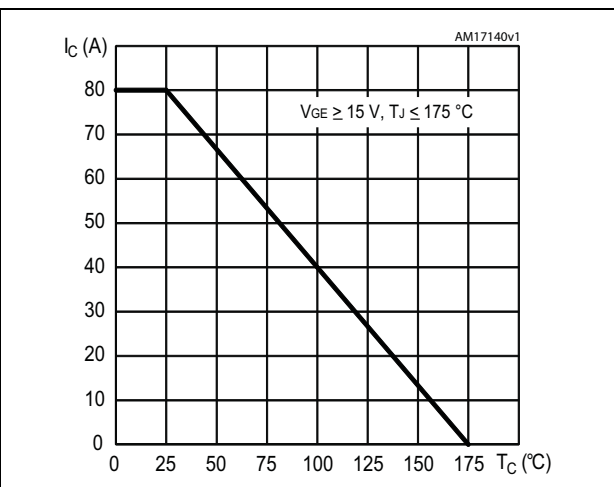

Figure 4. Output characteristics @ 25 °C

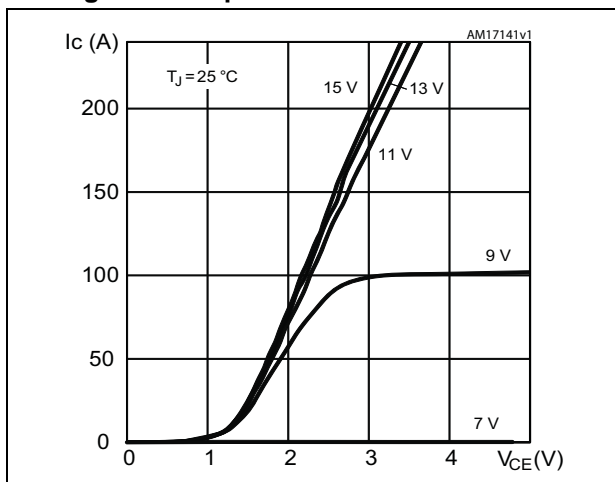

Figure 5. Output characteristics @ 175 °C

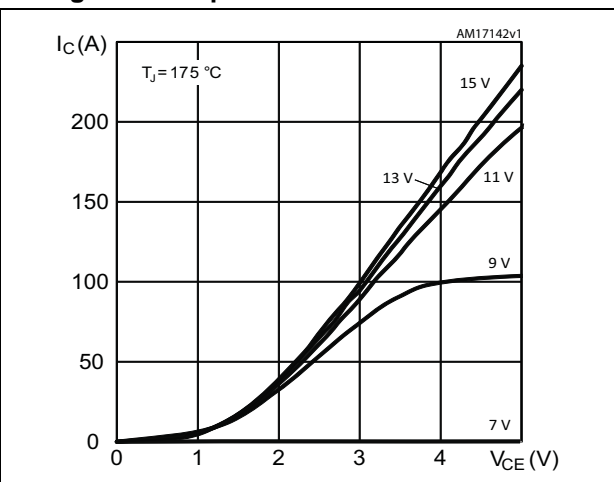

Figure 6. V\_CE(SAT) vs. junction temperature

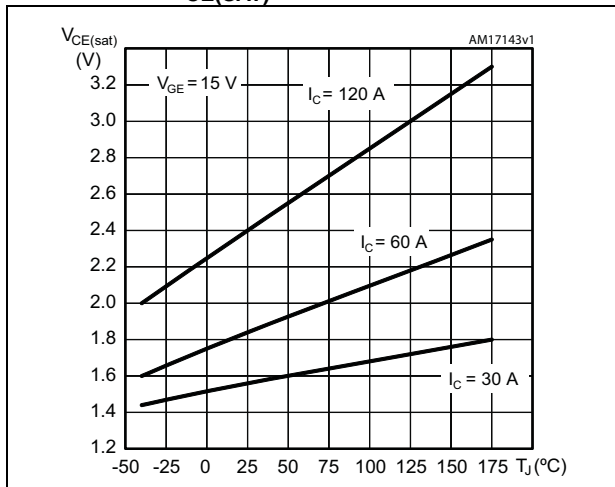

Figure 7. V\_CE(SAT) vs. collector current

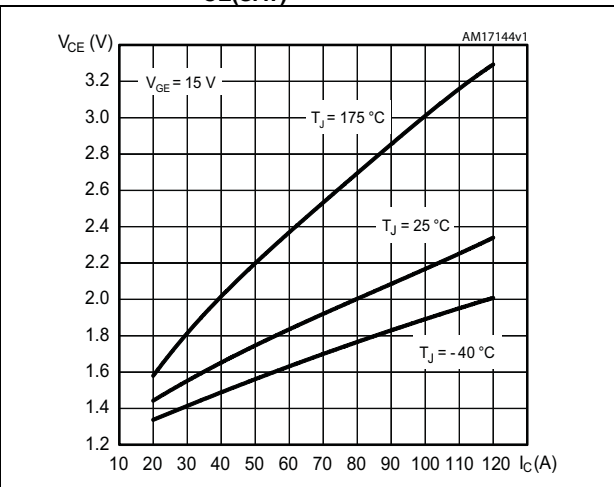

Figure 8. Collector current vs. switching frequency

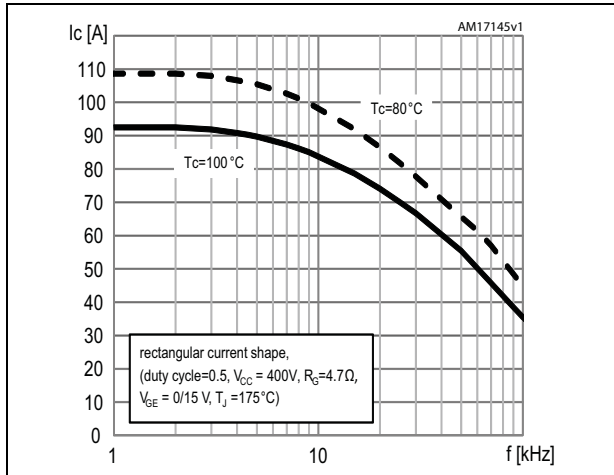

Figure 9. Forward bias safe operating area for TO-247

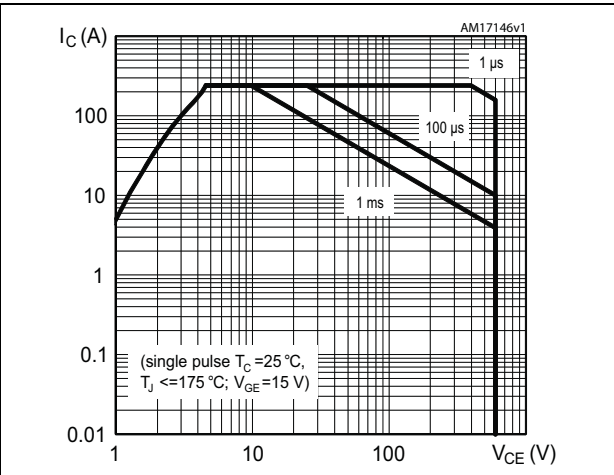

Figure 10. Normalized  $V_{GE(th)}$  vs. junction temperature

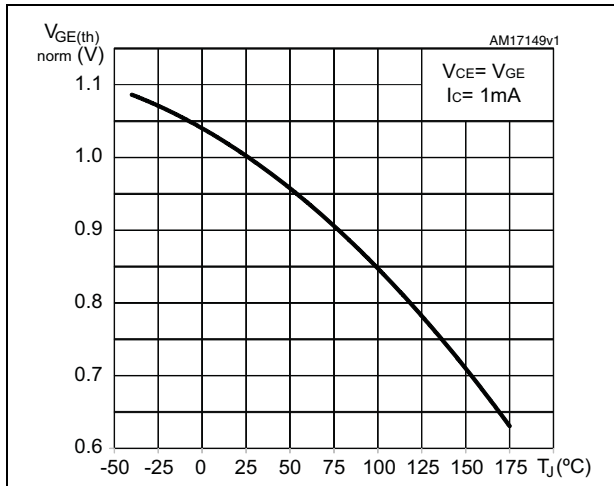

Figure 11. Normalized  $BV_{CES}$  vs. junction temperature

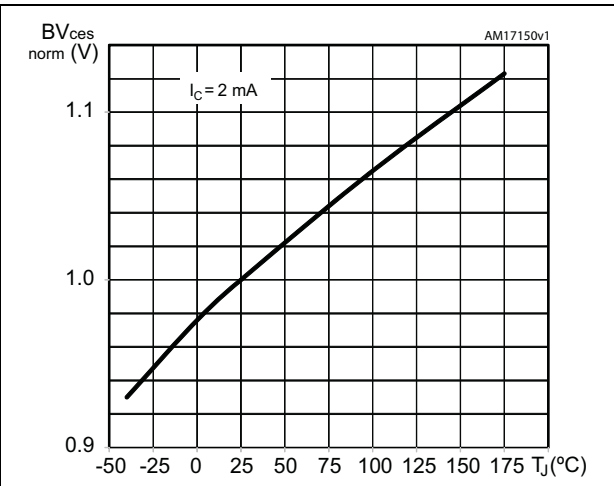

Figure 12. Capacitance variations

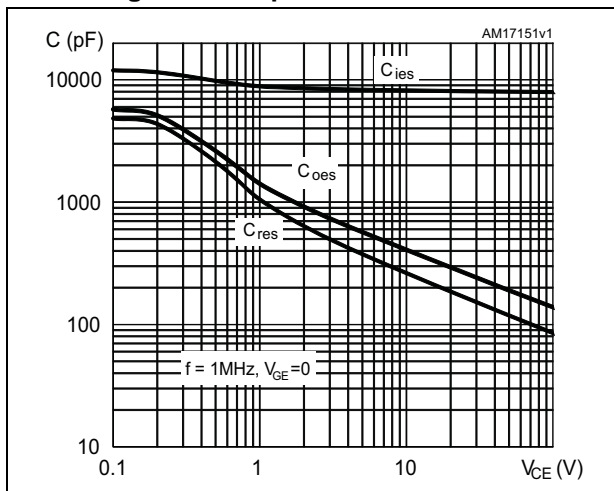

Figure 13. Gate charge vs. gate-emitter voltage

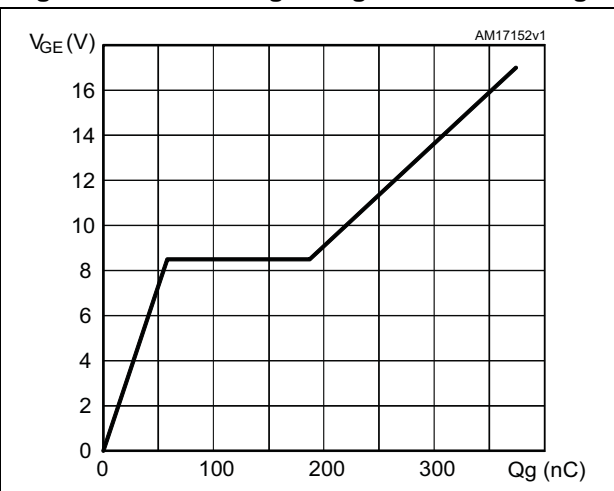

Figure 14. Switching losses vs. collector current

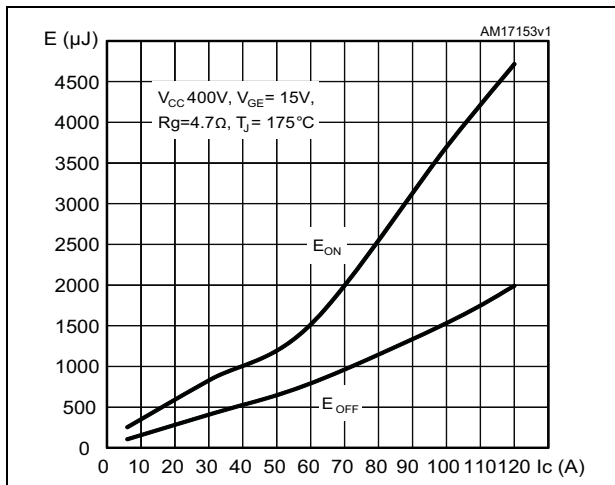

Figure 15. Switching losses vs. gate resistance

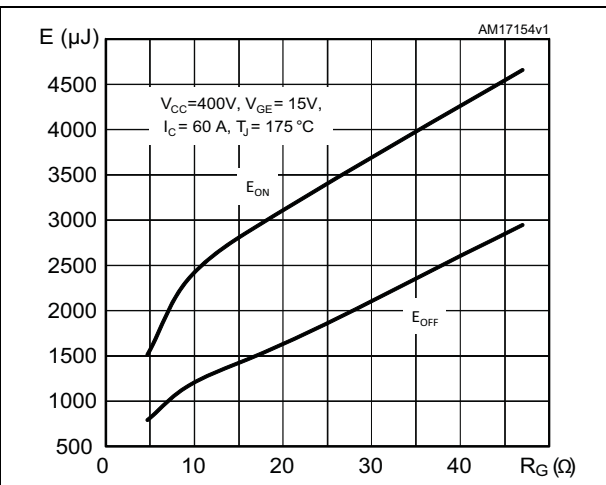

Figure 16. Switching losses vs. junction temperature

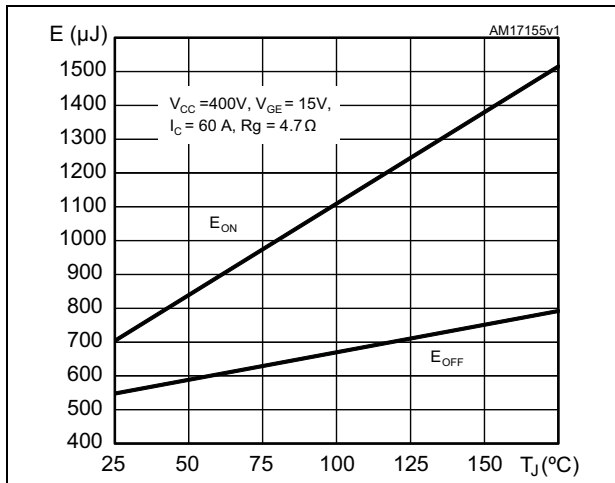

Figure 17. Switching losses vs. collector emitter voltage

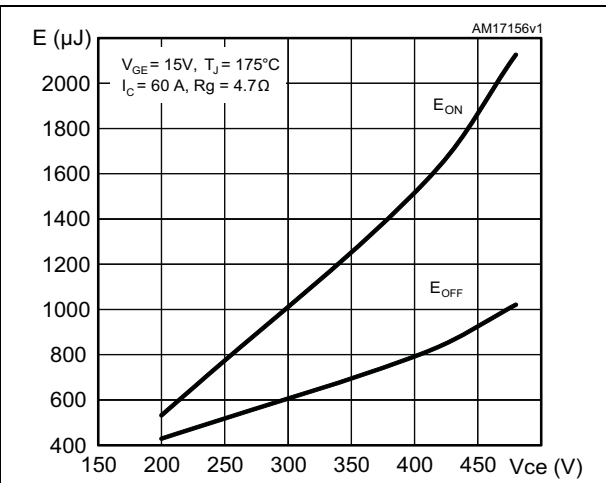

Figure 18. Switching times vs. collector current

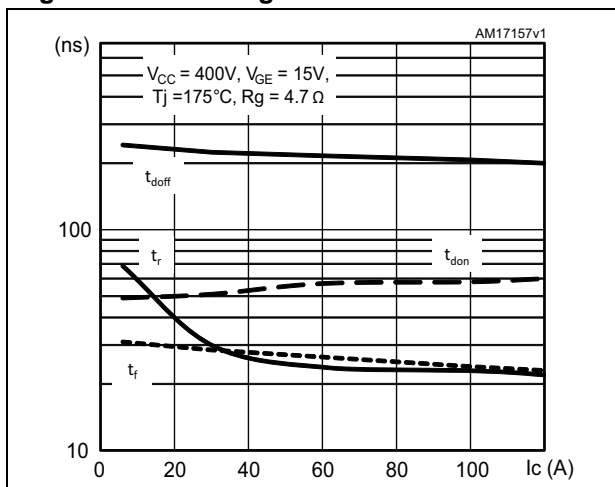

Figure 19. Switching times vs. gate resistance

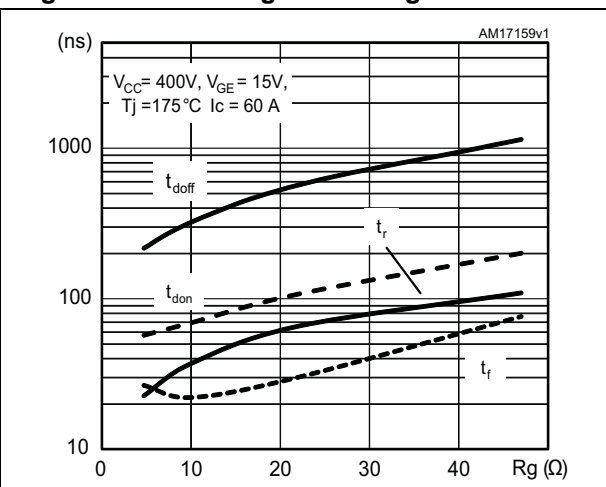



Figure 20. Transfer characteristics

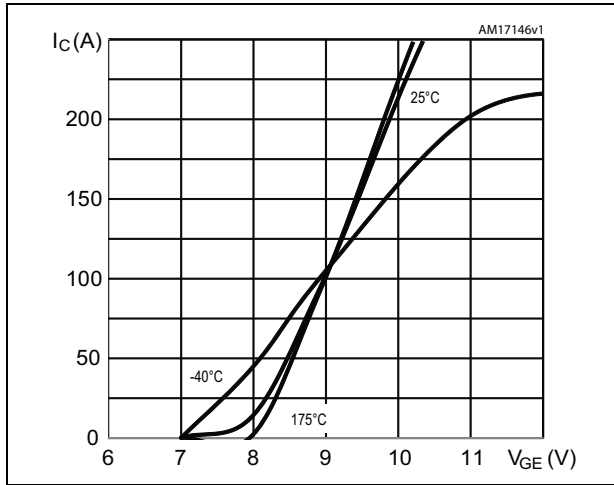
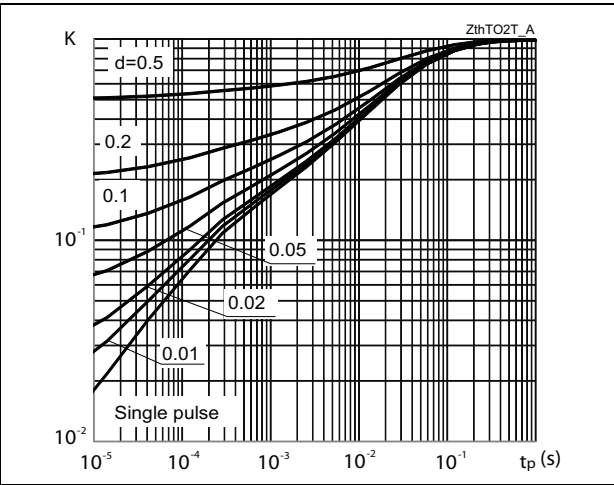

Figure 21. Thermal data



### 3 Test circuits

Figure 22. Test circuit for inductive load switching



Figure 23. Gate charge test circuit

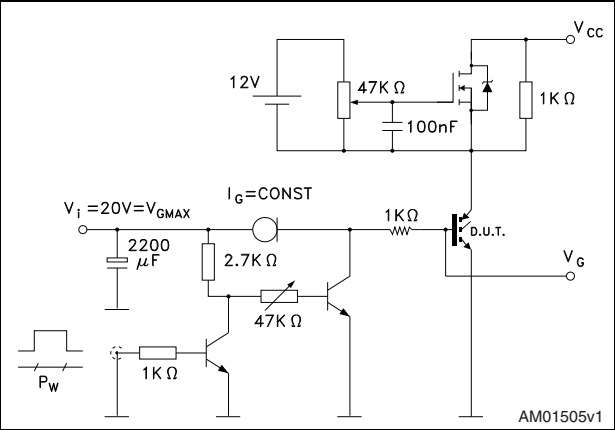
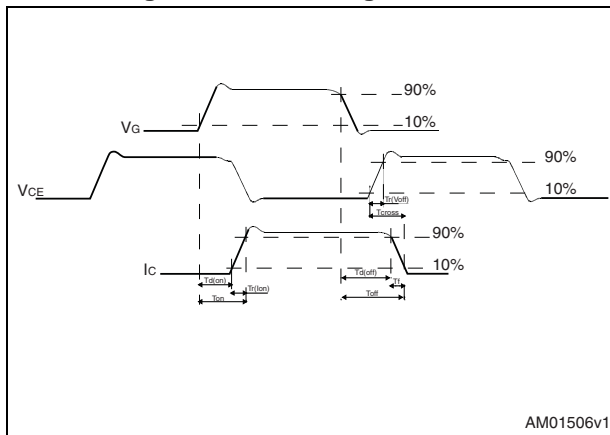

Figure 24. Switching waveform



## 4 Package mechanical data

In order to meet environmental requirements, ST offers these devices in different grades of ECOPACK® packages, depending on their level of environmental compliance. ECOPACK® specifications, grade definitions and product status are available at: [www.st.com](http://www.st.com). ECOPACK is an ST trademark.

**Table 7. TO-247 mechanical data**

Dim.	mm.		
	Min.	Typ.	Max.
A	4.85		5.15
A1	2.20		2.60
b	1.0		1.40
b1	2.0		2.40
b2	3.0		3.40
c	0.40		0.80
D	19.85		20.15
E	15.45		15.75
e	5.30	5.45	5.60
L	14.20		14.80
L1	3.70		4.30
L2		18.50	
ØP	3.55		3.65
ØR	4.50		5.50
S	5.30	5.50	5.70

Figure 25. TO-247 drawing

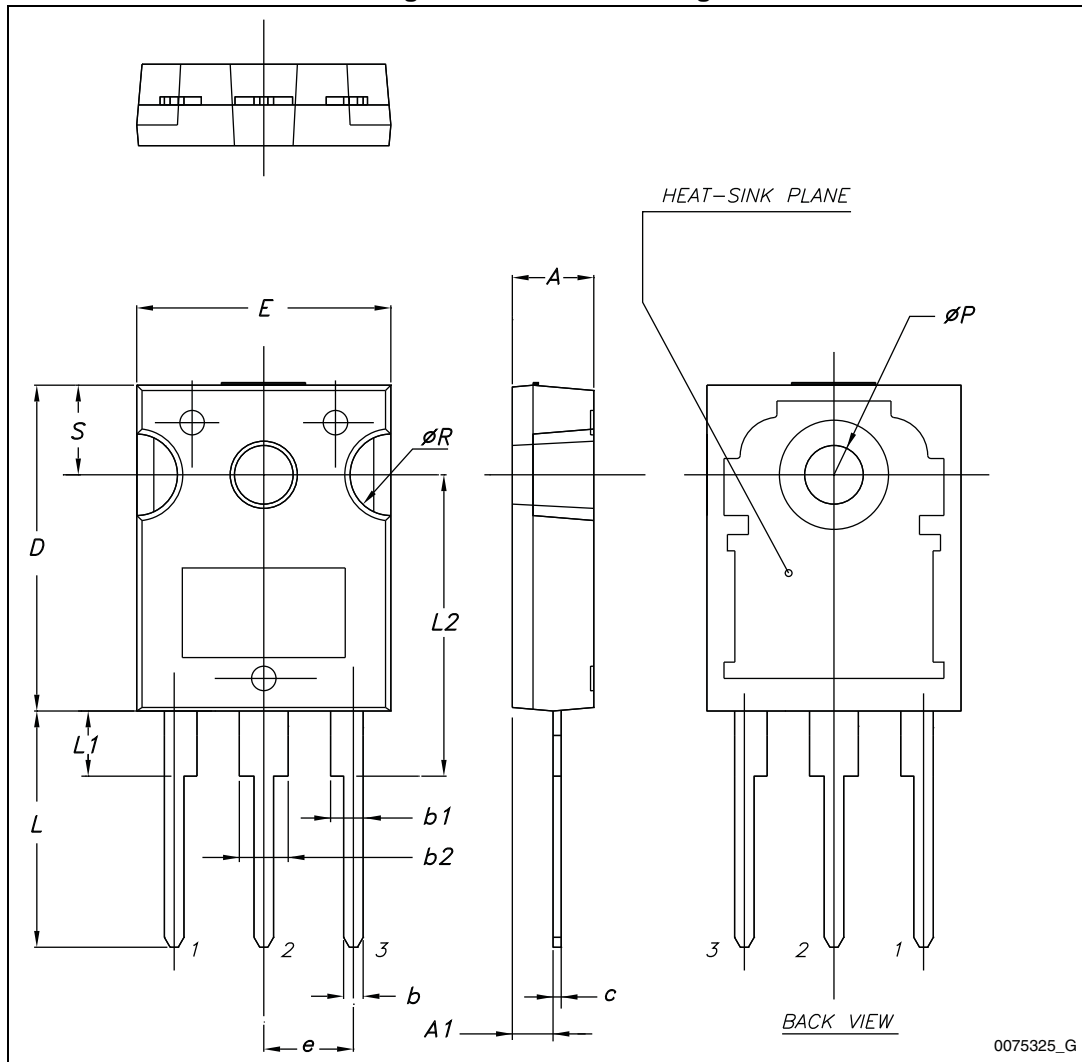

## 5 Revision history

**Table 8. Document revision history**

Date	Revision	Changes
04-Jun-2013	1	Initial release.

**Please Read Carefully:**

Information in this document is provided solely in connection with ST products. STMicroelectronics NV and its subsidiaries ("ST") reserve the right to make changes, corrections, modifications or improvements, to this document, and the products and services described herein at any time, without notice.

All ST products are sold pursuant to ST's terms and conditions of sale.

Purchasers are solely responsible for the choice, selection and use of the ST products and services described herein, and ST assumes no liability whatsoever relating to the choice, selection or use of the ST products and services described herein.

No license, express or implied, by estoppel or otherwise, to any intellectual property rights is granted under this document. If any part of this document refers to any third party products or services it shall not be deemed a license grant by ST for the use of such third party products or services, or any intellectual property contained therein or considered as a warranty covering the use in any manner whatsoever of such third party products or services or any intellectual property contained therein.

**UNLESS OTHERWISE SET FORTH IN ST'S TERMS AND CONDITIONS OF SALE ST DISCLAIMS ANY EXPRESS OR IMPLIED WARRANTY WITH RESPECT TO THE USE AND/OR SALE OF ST PRODUCTS INCLUDING WITHOUT LIMITATION IMPLIED WARRANTIES OF MERCHANTABILITY, FITNESS FOR A PARTICULAR PURPOSE (AND THEIR EQUIVALENTS UNDER THE LAWS OF ANY JURISDICTION), OR INFRINGEMENT OF ANY PATENT, COPYRIGHT OR OTHER INTELLECTUAL PROPERTY RIGHT.**

**ST PRODUCTS ARE NOT AUTHORIZED FOR USE IN WEAPONS. NOR ARE ST PRODUCTS DESIGNED OR AUTHORIZED FOR USE IN: (A) SAFETY CRITICAL APPLICATIONS SUCH AS LIFE SUPPORTING, ACTIVE IMPLANTED DEVICES OR SYSTEMS WITH PRODUCT FUNCTIONAL SAFETY REQUIREMENTS; (B) AERONAUTIC APPLICATIONS; (C) AUTOMOTIVE APPLICATIONS OR ENVIRONMENTS, AND/OR (D) AEROSPACE APPLICATIONS OR ENVIRONMENTS. WHERE ST PRODUCTS ARE NOT DESIGNED FOR SUCH USE, THE PURCHASER SHALL USE PRODUCTS AT PURCHASER'S SOLE RISK, EVEN IF ST HAS BEEN INFORMED IN WRITING OF SUCH USAGE, UNLESS A PRODUCT IS EXPRESSLY DESIGNATED BY ST AS BEING INTENDED FOR "AUTOMOTIVE, AUTOMOTIVE SAFETY OR MEDICAL" INDUSTRY DOMAINS ACCORDING TO ST PRODUCT DESIGN SPECIFICATIONS. PRODUCTS FORMALLY ESCC, QML OR JAN QUALIFIED ARE DEEMED SUITABLE FOR USE IN AEROSPACE BY THE CORRESPONDING GOVERNMENTAL AGENCY.**

Resale of ST products with provisions different from the statements and/or technical features set forth in this document shall immediately void any warranty granted by ST for the ST product or service described herein and shall not create or extend in any manner whatsoever, any liability of ST.

ST and the ST logo are trademarks or registered trademarks of ST in various countries.

Information in this document supersedes and replaces all information previously supplied.

The ST logo is a registered trademark of STMicroelectronics. All other names are the property of their respective owners.

© 2013 STMicroelectronics - All rights reserved

STMicroelectronics group of companies

Australia - Belgium - Brazil - Canada - China - Czech Republic - Finland - France - Germany - Hong Kong - India - Israel - Italy - Japan - Malaysia - Malta - Morocco - Philippines - Singapore - Spain - Sweden - Switzerland - United Kingdom - United States of America

[www.st.com](http://www.st.com)