

# TR4N 1 CO, 2 CO

## time relays



- 10-function electronic time relays in compact cover
- Cadmium - free contacts
- AC and AC/DC input voltages
- Direct mounting on 35 mm rail mount acc. to PN-EN 60715
- The main advantages of application: simple selection of the performed function, possibility to control one or two circuits (1 or 2 changeover contacts), esthetic design in the control cabinet
- The switching capacity of contacts as in RM85 (1 CO) or RM84 (2 CO) electromagnetic relay
- Compliance with standard PN-EN 61812-1
- Recognitions, certifications, directives: **CE** **PG**

### Output circuits - contact data

Number and type of contacts		1 CO	2 CO
Contact material		<b>AgNi</b>	<b>AgNi</b>
Max. switching voltage		440 V AC / 300 V DC	440 V AC / 300 V DC
Rated load	AC1	16 A / 250 V AC	8 A / 250 V AC
	DC1	16 A / 24 V DC; 0,3 A / 250 V DC	8 A / 24 V DC; 0,3 A / 250 V DC
Rated current		16 A	8 A
Max. breaking capacity		4 000 VA	2 000 VA
Min. breaking capacity		0,3 W 5 V, 5 mA	
Contact resistance		≤ 100 mΩ	
Max. operating frequency	AC1	• at rated load	
		• no load	
		600 cycles/hour	18 000 cycles/hour
<b>Input circuit</b>			
Rated voltage	50/60 Hz AC	115 ... 230 V	
	AC: 50/60 Hz AC/DC	12 ... 24 V	
Operating range of supply voltage		0,9...1,2 U <sub>n</sub> 12 V AC/DC	0,85...1,2 U <sub>n</sub> 24 V AC/DC, 115 V AC, 230 V AC
Rated power consumption	AC	1,3 VA 115 V AC	1,7 VA 230 V AC
	AC/DC	0,5 VA / 0,5 W 12 V AC/DC	0,7 VA / 0,7 W 24 V AC/DC
Range of supply frequency	AC	48...63 Hz	
	AC/DC	48...100 Hz	
<b>Control contact S ①</b>			
• min. voltage ②		0,6 U <sub>n</sub>	
• min. time of pulse duration ②		AC: ≥ 25 ms	DC: ≥ 15 ms
<b>Insulation according to PN-EN 60664-1</b>			
Insulation category		B250	
Overvoltage category		III	
Insulation pollution degree		2	
Flammability degree		V-1 UL94	
Dielectric strength			
• input - outputs		2 000 V AC	type of insulation: basic
• contact clearance		1 000 V AC	type of clearance: micro-disconnection
Input - outputs distance			
• clearance		≥ 10 mm	
• creepage		≥ 10 mm	
<b>General data</b>			
Electrical life			
• resistive AC1		> 0,7 x 10 <sup>5</sup> 16 A, 250 V AC	> 10 <sup>5</sup> 8 A, 250 V AC
Mechanical life (cycles)		> 3 x 10 <sup>7</sup>	
Dimensions (L x W x H)		90 x 17,6 x 55 mm	
Weight		67 g	
Ambient temperature	• storage	-40...+70 °C	
	• operating	-20...+55 °C	
Cover protection category		IP 20	PN-EN 60529
Environmental protection		RTI	PN-EN 116000-3
Shock resistance		15 g	
Vibration resistance		0,35 mm DA 10...55 Hz	

The data in bold type pertain to the standard versions of the relays.

① The control terminal S is activated by connection to A1 terminal via the external control contact S.

② Where the control signal is recognizable.

# TR4N 1 CO, 2 CO time relays

## Time module data

Functions	E, Wu, Bp, Bi, PWM, R, Ws, Wa, Esa, B permanent switching ON and OFF
Time ranges	1 s ①; 10 s; 1 min.; 10 min.; 1 h; 10 h; 1 d; 10 d
Timing adjustment	smooth - (0,1...1) x time range
Setting accuracy	± 5% (calculated from the final range values) ②
Repeatability	± 0,5% ③
Temperature influence	± 0,01% / °C
Recovery time	80 ms
LED indicator	green LED - indication of supply voltage U yellow LED - indication of time period T and the status of outputs after the time T has been measured ④

① For first range setpoint (1 s) setting accuracy and repeatability are smaller than the given ones in technical parameters (significant influence of the operational relay operating time). Recommend to set measuring time by experimental method. ② The yellow LED - T time measurement (pulsating); excited operational relay; time not measured (steady light); de-excited operational relay, time not measured (no light).

## Dimensions

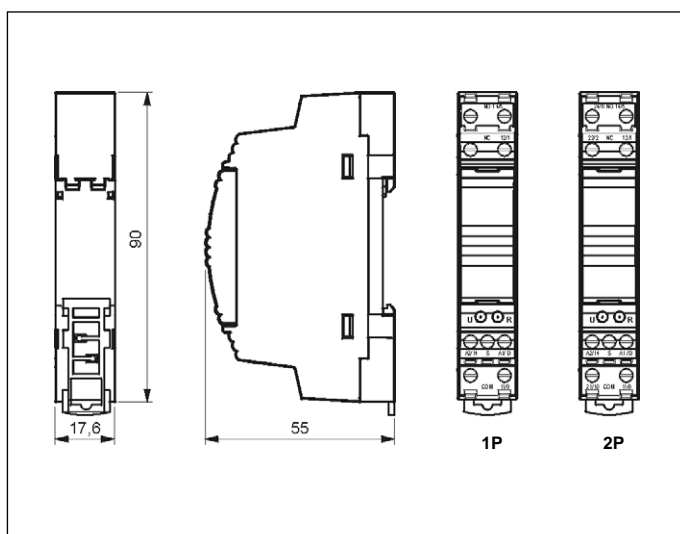

## Front panel description

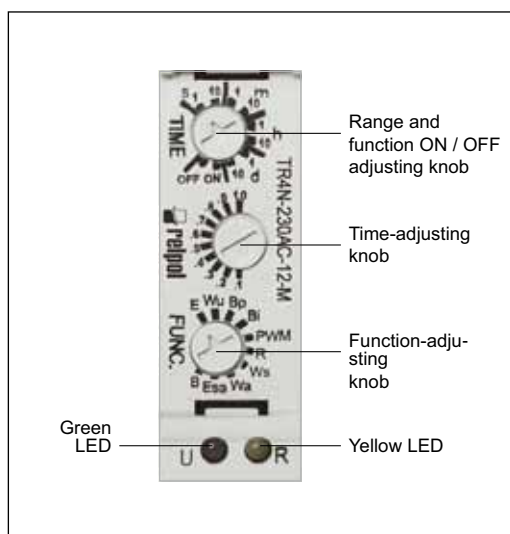

**Electrical life at AC resistive current.**  
Switching frequency: 600 cycles/hour  
- TR4N 1 CO

Fig. 1

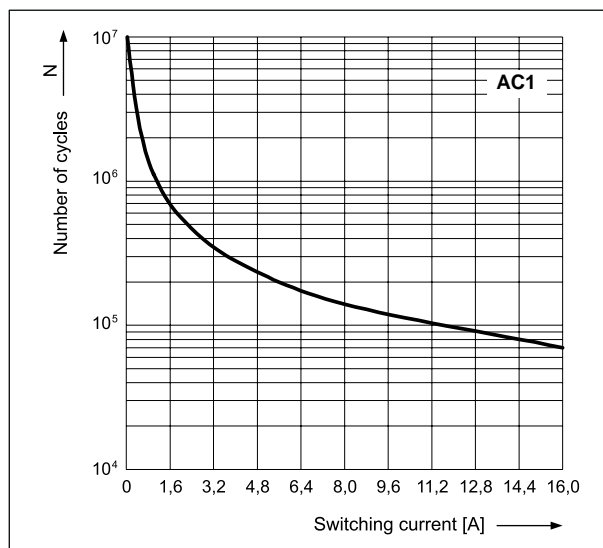

**Electrical life at AC resistive current.**  
Switching frequency: 600 cycles/hour  
- TR4N 2 CO

Fig. 2

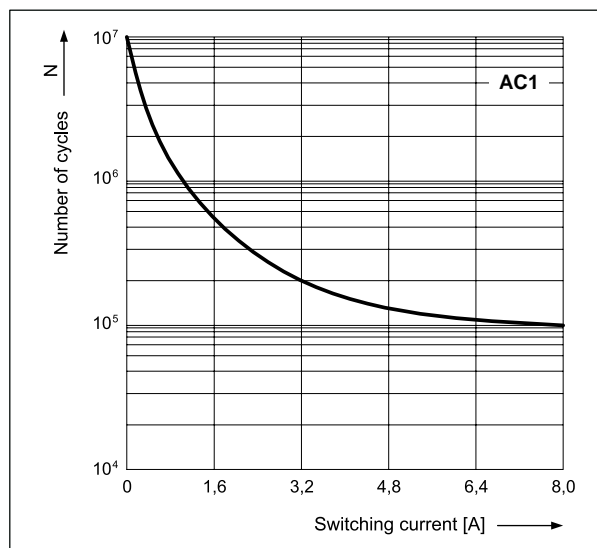

## Time functions

### E - ON delay.

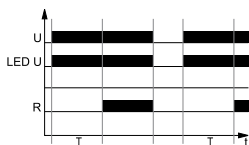

On applying the supply voltage U the set interval T begins - off-delay of the output relay R. After the interval T has lapsed, the output relay R switches on and remains on until supply voltage U is interrupted.

### Wu - ON for the set interval.

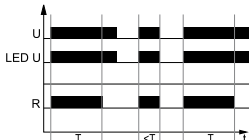

Applying the supply voltage U immediately switches the output relay R on for the set interval T. After the interval T has lapsed, the output relay R switches off.

### Bp - Symmetrical cyclical operation pause first.

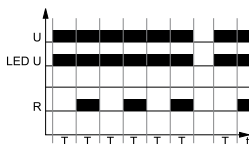

Applying the supply voltage U starts the cyclical operation from the T interval - switching the output relay R off followed by switching on the output relay R for the interval T. The cyclical operation lasts until the supply voltage U is interrupted.

### Bi - Symmetrical cyclical operation pulse first.

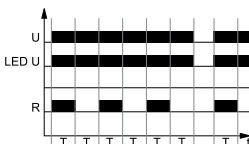

Applying the supply voltage U starts the cyclical operation from switching on the output relay R for the set interval T. After the interval T has lapsed, the output relay R switches off for the interval T. The cyclical operation lasts until the supply voltage U is interrupted.

### PWM - Pulse width modulation.

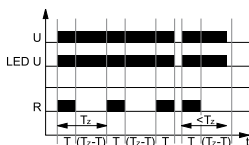

Set the relay to a single  $T_z$  cycle which is one of the time ranges available for a time relay. The cycle shall be set with the time selection knob. Then, set the interval T, i.e. the ON time of the output relay R with the time fine setting knob. The interval T may be set from 0.1 to 1.0 of the time range ( $T_z$  cycle). Applying the supply voltage U immediately switches on the output relay R for the set interval, and after the interval has lapsed, the output relay R switches off for the time left until the set time  $T_z$ . After the  $T_z$  time, consecutive cycles start and are continued until the supply voltage U is interrupted. In the course of the PWM function, the ON time of the output relay R may be changed, and such change does not affect the interval of the  $T_z$  cycle. The changed ON time of the output relay R shall be realized starting from the new  $T_z$  cycle following the change.

U - supply voltage; R - output state of the relay; S - control contact state;  $T_z$  - value of the set interval; T - measured time; t - time axis

### R - OFF delay with the control contact S.

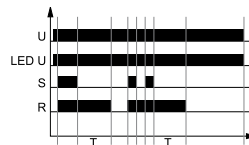

The input of the time relay is supplied with voltage U continuously. Closing of the control contact S immediately switches on the output relay R. Opening of the control contact S starts the set time of the delayed switching off of the output relay R. After the interval T has lapsed, the output relay R switches off. If the control contact S is closed during the interval T, the already measured time is reset, and the output relay R is switched on again. The OFF delay of the output relay R will start when the control contact S is opened again.

### Ws - Single shot for the set interval triggered by closing of the control contact S.

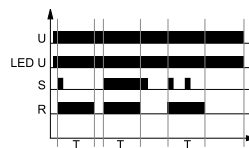

The input of the time relay is supplied with voltage U continuously. Closing of the control contact S immediately switches the output relay R on for the set interval T. After the interval T has lapsed, the output relay R is switched off. In the course of the interval T, any opening of the control contact S does not affect the function to be performed. The output relay R may be switched on again for the set interval, after the interval T has lapsed, by closing the control contact S again.

### Wa - ON for the set interval triggered with the control contact S.

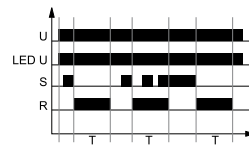

The input of the time relay is supplied with voltage U continuously. Closing of the control contact S does not start the interval T, and it does not change the position of the output relay R. Opening of the control contact S immediately switches on the output relay R for the set time. After the interval T has lapsed, the output relay R switches off. Opening and closing of the control contact S in the course of the interval T does not affect the function to be performed. The output relay R may be switched on again for the set interval with another closing and opening of the control contact S.

## Connections diagrams

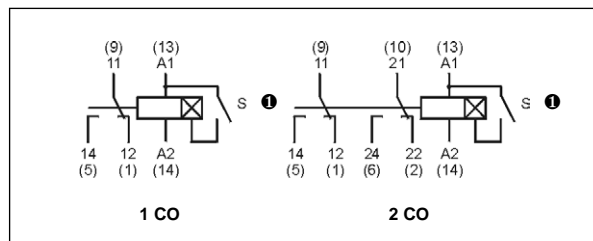

① The control terminal S is activated by connection to A1 terminal via the external control contact S.

# TR4N 1 CO, 2 CO time relays

## Time functions

**Esa** - ON and OFF delay with the control contact S.

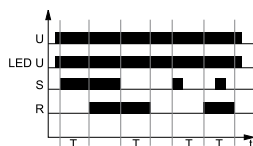

The input of the time relay is supplied with voltage U continuously. Closing of the control contact S starts the interval T - on-delay of the output relay R. After the interval T has lapsed, the output relay R switches on. Opening of the control contact S begins further measurement of the interval T - off-delay of the output relay R, and after the interval has lapsed, the output relay switches off. In case the time for which the control contact S is closed in the course of measurement of the on-delay of the output relay R is shorter than the set interval T, the output relay R will switch on after the set interval T, and the output relay R will remain in on position for the interval T. When the output relay R is in on position, closing of the control contact S does not affect the function to be performed.

**B** - Cyclical operation controlled with closing of the control contact S.

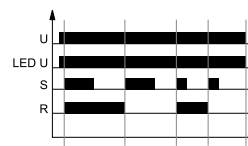

The input of the time relay is supplied with U voltage continuously. Closing of the control contact S immediately switches on the output relay R. Each next closing of the control contact S results in a change of the status of the output relay R to an opposite one (the feature of a bistable relay).

Permanent switching ON and OFF.

The functions ON and OFF are selected with TIME potentiometer. In the ON function, the normally open contacts are closed all the time whereas in the OFF function they are open. The position of the FUNC potentiometer is of no significance in these functions as is the preset measurement time. The ON or OFF functions are used for the time relay operation control in electric systems.

U - supply voltage; R - output state of the relay; S - control contact state; Tz - value of the set interval; T - measured time; t - time axis

## Mounting

Relays TR4N 1 CO, 2 CO are designed for direct mounting on 35 mm rail mount acc. to PN-EN 60715. Operational position - any. **Connections:** max. cross section of the cables: 1 x 2,5 mm<sup>2</sup> / 2 x 1,5 mm<sup>2</sup> (1 x 14 / 2 x 16 AWG), length of the cable deinsulation: 6,5 mm, max. tightening moment for the terminal: 0,6 Nm.

**One tap:**  
easy assembly  
on 35 mm rail,  
firm tapping (bottom).



## Ordering codes

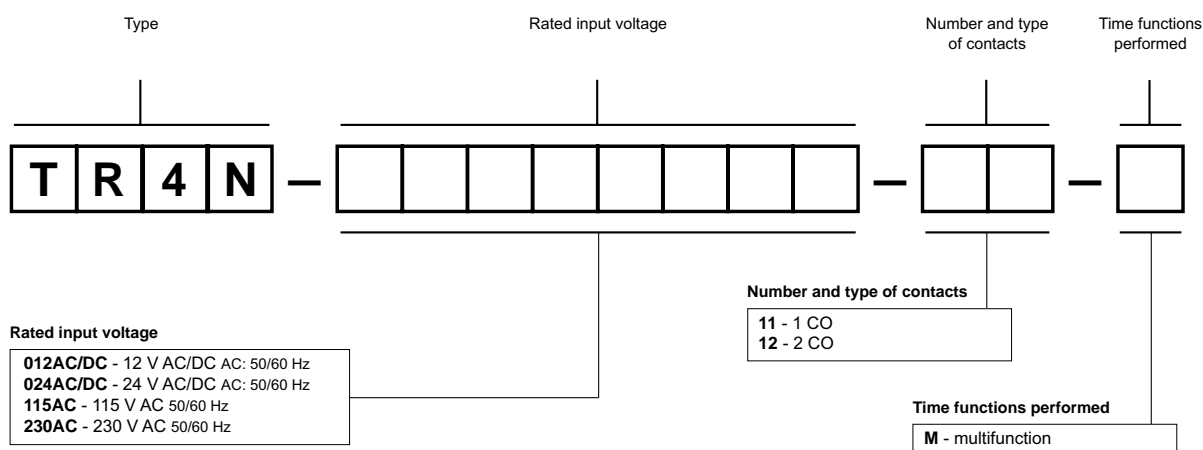

Examples of ordering codes:

**TR4N-230AC-11-M**

time relay TR4N 1 CO, multifunction (relay perform 10 functions), one changeover contact, contact material AgNi, rated input voltage 230 V AC 50/60 Hz

**TR4N-024AC/DC-12-M**

time relay TR4N 2 CO, multifunction (relay perform 10 functions), two changeover contacts, contact material AgNi, rated input voltage 24 V AC/DC AC: 50/60 Hz

### PRECAUTIONS:

1. Ensure that the parameters of the product described in its specification provide a safety margin for the appropriate operation of the device or system and never use the product in circumstances which exceed the parameters of the product. 2. Never touch any live parts of the device. 3. Ensure that the product has been connected correctly. An incorrect connection may cause malfunction, excessive heating or risk of fire. 4. In case of any risk of any serious material loss or death or injuries of humans or animals, the devices or systems shall be designed so to equip them with double safety system to guarantee their reliable operation.