

International Rectifier

40HFL, 70HFL, 85HFL SERIES

FAST RECOVERY DIODES

Stud Version



Major Ratings and Characteristics

Parameters	40HFL	70HFL	85HFL	Units	
$I_{F(AV)}$	40	70	85	A	
@ Max Tc	75	75	75	A	
I_{FSM}	@ 50Hz	400	700	1100	A
	@ 60Hz	420	730	1151	A
I^2t	@ 50Hz	800	2450	6050	A ² s
	@ 60Hz	730	2240	5523	A ² s
I^2vt	11300	34650	85560	I ² v s	
V_{RRM} range	100 to 1000			V	
t_{rr} range	see table			ns	
T_j range	- 40 to 125			°C	

Description

This range of fast recovery diodes is designed for applications in DC power supplies, inverters, converters, choppers, ultrasonic systems and for use as a free wheeling diode.

Features

- Short reverse recovery time
- Low stored charge
- Wide current range
- Excellent surge capabilities
- Stud cathode and stud anode versions
- Types up to 1000V_{RRM}

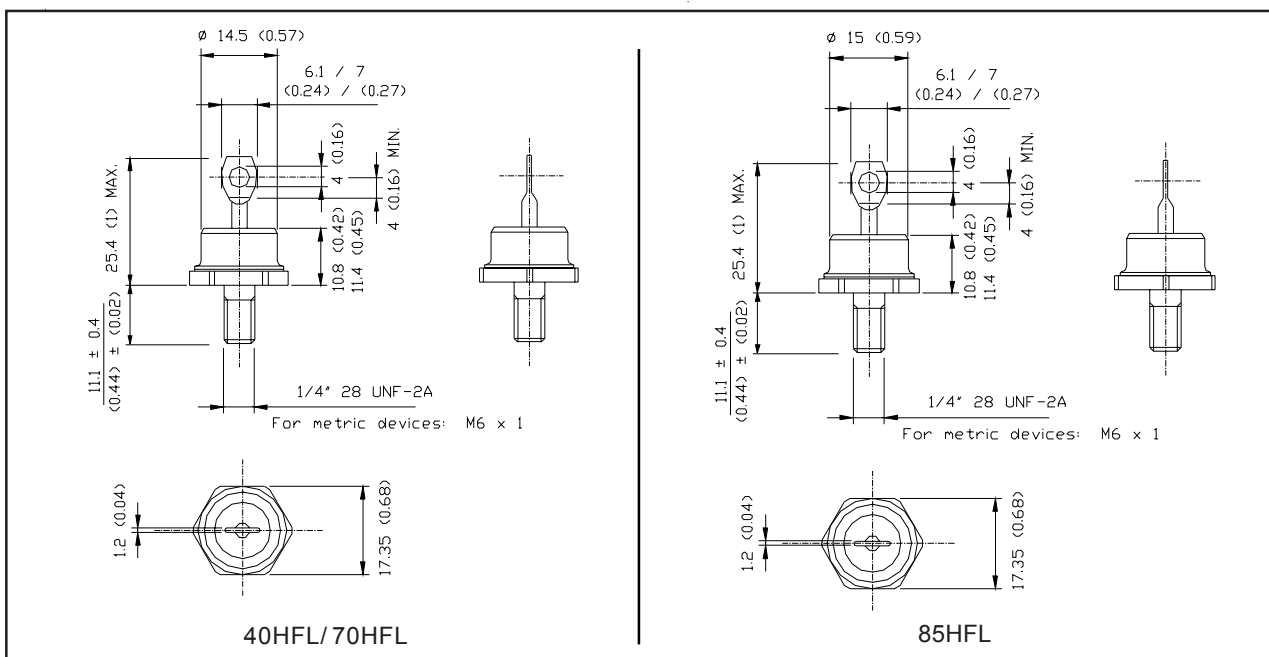

ELECTRICAL SPECIFICATIONS

Reverse voltage ratings

Part number ①	V_{RRM} , Maximum peak repetitive reverse voltage $T_J = -40$ to 125°C	V_{RRM} , Maximum peak non-repetitive reverse voltage $T_J = 25$ to 125°C	I_{FRM} Maximum peak reverse current at rated V_{RRM}	
	V	V	$T_J = 25^\circ\text{C}$ mA	$T_J = 125^\circ\text{C}$ mA
40HFL10S02, 40HFL10S05, 40HFL10S10 40HFL20S02, 40HFL20S05, 40HFL20S10 40HFL40S02, 40HFL40S05, 40HFL40S10 40HFL60S02, 40HFL60S05, 40HFL60S10 40HFL80S05, 40HFL80S10 40HFL100S05, 40HFL100S10	100 200 400 600 800 1000	150 300 500 700 900 1100	0.1 0.1 0.1 0.1 0.1 0.1	10 10 10 10 10 10
70HFL10S02, 70HFL10S05, 70HFL10S10 70HFL20S02, 70HFL20S05, 70HFL20S10 70HFL40S02, 70HFL40S05, 70HFL40S10 70HFL60S02, 70HFL60S05, 70HFL60S10 70HFL80S05, 70HFL80S10 70HFL100S05, 70HFL100S10	100 200 400 600 800 1000	150 300 500 700 900 1100	0.1 0.1 0.1 0.1 0.1 0.1	15 15 15 15 15 15
85HFL10S02, 85HFL10S05, 85HFL10S10 85HFL20S02, 85HFL20S05, 85HFL20S10 85HFL40S02, 85HFL40S05, 85HFL40S10 85HFL60S02, 85HFL60S05, 85HFL60S10 85HFL80S05, 85HFL80S10 85HFL100S05, 85HFL100S10	100 200 400 600 800 1000	150 300 500 700 900 1100	0.1 0.1 0.1 0.1 0.1 0.1	20 20 20 20 20 20

① Types listed are cathode case, for anode case add "R" to code, i.e. 40HFLR20S02, 85HFLR100S05 etc.

Reverse recovery characteristics

	40HFL...			70HFL...			85HFL...			Units	Conditions
	S02	S05	S10	S02	S05	S10	S02	S05	S10		
t_{rr} Typical reverse recovery time	70	180	350	60	150	290	50	120	270	ns	$T_J = 25^\circ\text{C}$, $I_F = 1\text{A}$ to $V_R = 30\text{V}$ $-di_F/dt = 100\text{A}/\mu\text{s}$
	200	500	1000	200	500	1000	200	500	1000	ns	$T_J = 25^\circ\text{C}$, $-di_F/dt = 25\text{A}/\mu\text{s}$ $I_{FM} = \tau \times \text{rated } I_{F(AV)}$
Q_{RR} Typical reverse recovered charge	160	750	3100	90	500	1600	70	340	1350	nC	$T_J = 25^\circ\text{C}$, $I_F = 1\text{A}$ to $V_R = 30\text{V}$ $-di_F/dt = 100\text{A}/\mu\text{s}$
	240	1300	6000	240	1300	6000	240	1300	6000	nC	$T_J = 25^\circ\text{C}$, $-di_F/dt = 25\text{A}/\mu\text{s}$ $I_{FM} = \tau \times \text{rated } I_{F(AV)}$

Forward conduction

	40HFL	70HFL	85HFL	Units	Conditions
$I_{F(AV)}$ Maximum average forward current	40	70	85	A	180°C conduction, half sine wave, max. $T_C = 75^\circ\text{C}$
$I_{F(RMS)}$ Maximum RMS forward current	63	110	134	A	
I_{FRM} Maximum peak repetitive forward current	220	380	470	A	Sinusoidal half wave, 30° conduction
I_{FSM} Maximum peak, one cycle non-repetitive forward current	400	700	1100	A	$t = 10\text{ms}$ Sinusoidal half-wave 100% V_{RRM} reapplied, initial $T_J = T_{J \text{ max}}$
	420	730	1151	A	$t = 8.3\text{ms}$
	475	830	1308	A	$t = 10\text{ms}$ Sinusoidal half-wave no voltage reapplied, initial $T_J = T_{J \text{ max}}$
	500	870	1369	A	$t = 8.3\text{ms}$
I^2t Maximum I^2t for fusing	800	2450	6050	A^2s	$t = 10\text{ms}$ 100% V_{RRM} reapplied initial $T_J = T_{J \text{ max}}$
	730	2240	5523	A^2s	$t = 8.3\text{ms}$
	1130	3460	8556	A^2s	$t = 10\text{ms}$ No voltage reapplied initial $T_J = T_{J \text{ max}}$
	1030	3160	7810	A^2s	$t = 8.3\text{ms}$
$I^2\sqrt{t}$ Maximum $I^2\sqrt{t}$ for fusing ①	11 300	34 650	85 560	A^2/s	$t = 0.1$ to 10ms , no voltage reapplied
$V_{F(TO)}$ Maximum value of threshold voltage	1.081	1.085	1.128	V	$T_J = 125^\circ\text{C}$
r_F Maximum value of forward slope resistance	6.33	3.40	2.11	$\text{m}\Omega$	
V_{FM} Maximum peak forward voltage	1.95	1.85	1.75	V	$T_J = 25^\circ\text{C}$, $I_{FM} = \tau \times I_{F(AV)}$

① I^2t for time $t_x = I^2\sqrt{t} + \sqrt{t_x}$.

THERMAL AND MECHANICAL SPECIFICATIONS

		40HFL...	70HFL...	85HFL...	Units	Conditions
T_j	Junction operating temperature range	-40 to 125			°C	
T_{stg}	Storage temperature range	-40 to 150			°C	
R_{thJC}	Maximum internal thermal resistance, junction to case	0.60	0.36	0.30	K/W	DC operation
R_{thCS}	Maximum thermal resistance, case to heatsink	0.25			K/W	Mounting surface, smooth, flat and greased
T	Mounting torque 10%	to nut	20 (27)		lbf·in	Lubricated threads (non-lubricated threads)
			0.23 (0.29)		kgf·m	
			2.2 (2.7)		N·m	
	to device	22		lbf·in		
		0.25		kgf·m		
		2.5		N·m		
wt	Approximate weight	25 (0.88)			g (oz)	
	Outline	DO-203AB (DO-5)				JEDEC

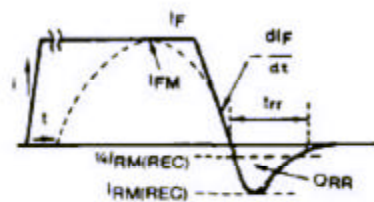

- I_F, I_{FM} = Peak forward current prior to commutation
- $-dI_F/dt$ = Rate of fall of forward current
- $I_{RM(REC)}$ = Peak reverse recovery current
- t_{rr} = Reverse recovery time
- ORR = Reverse recovered charge

Fig. 1 — Reverse Recovery Time Test Waveform

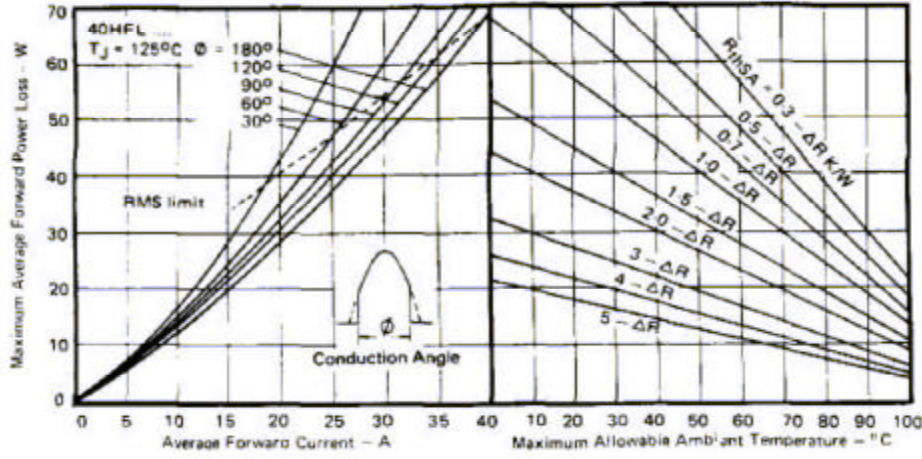

Conduction angle - ϕ	ΔR	K/W
180°	0.14	
120°	0.15	
90°	0.20	
60°	0.31	
30°	0.53	

Fig. 2 - Current Rating Nomogram (Sinusoidal Waveforms), 40HFL Series

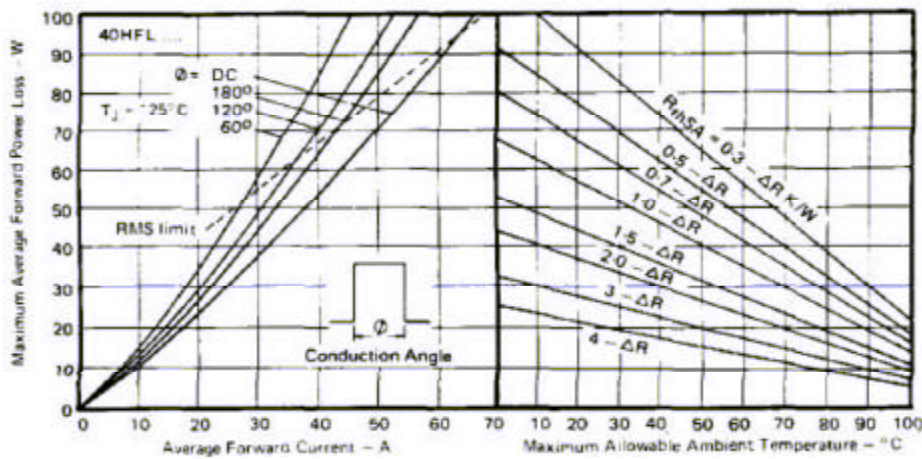

Conduction angle - ϕ	ΔR	K/W
DC	0	
180°	0.08	
120°	0.14	
90°	0.30	

Fig. 3 - Current Rating Nomogram (Rectangular Waveforms), 40HFL Series

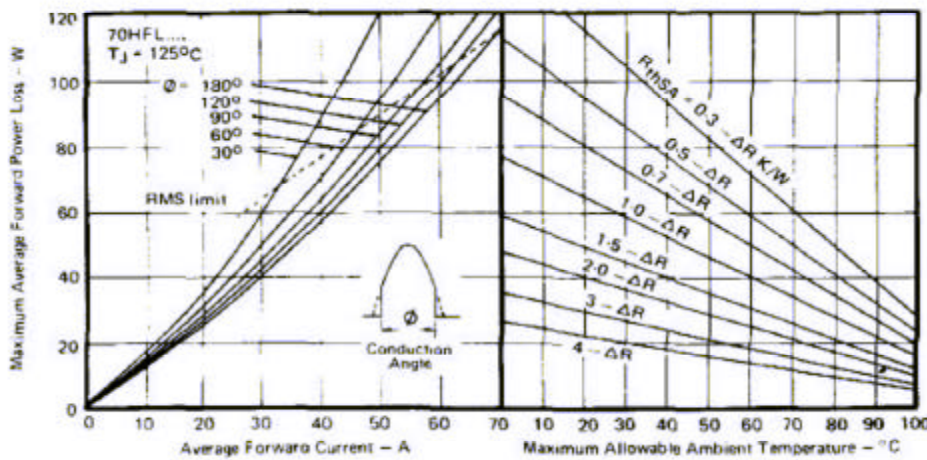

Conduction angle - ϕ	ΔR	K/W
180°	0.08	
120°	0.09	
90°	0.12	
60°	0.18	
30°	0.32	

Fig. 4 - Current Rating Nomogram (Sinusoidal Waveforms), 70HFL Series

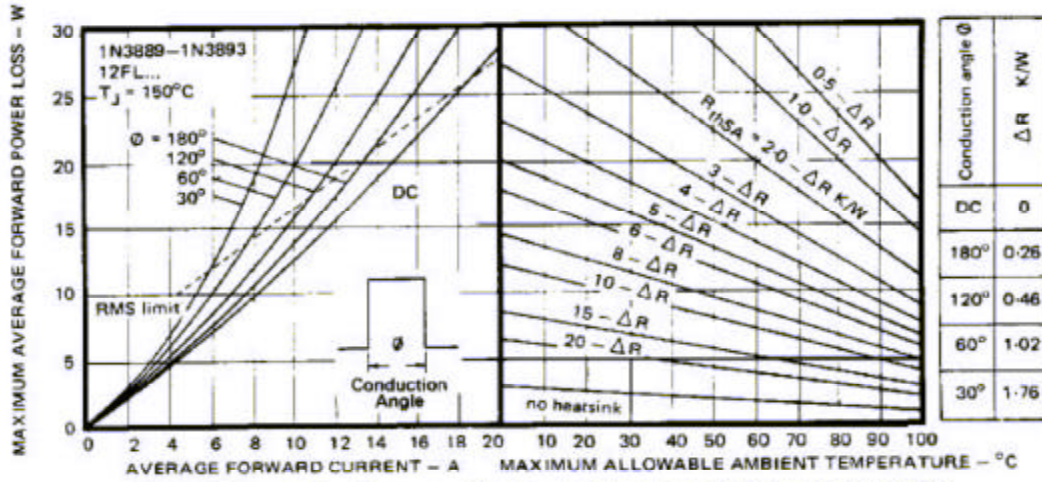

Fig. 8 - Current Rating Nomogram (Rectangular Waveforms), 1N3889 and 12FL Series

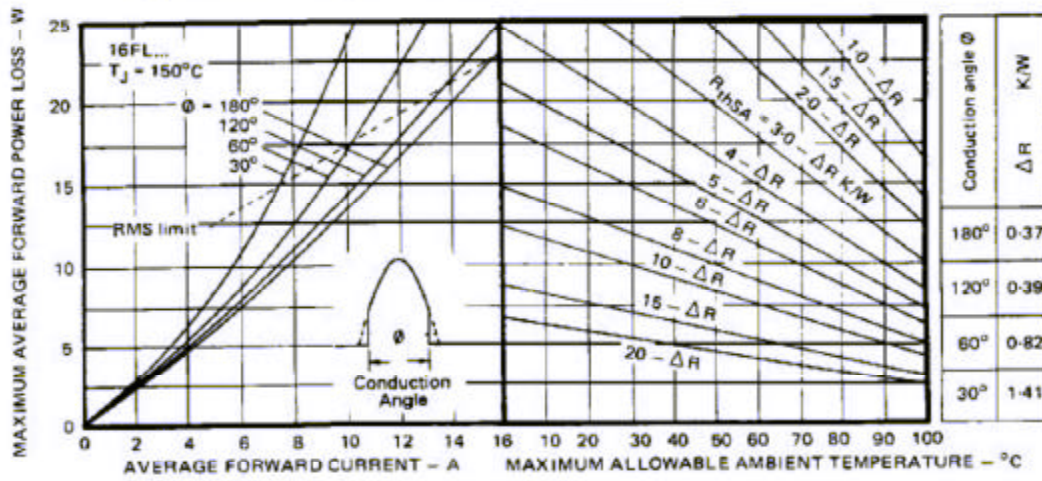

Fig. 9 - Current Rating Nomogram (Sinusoidal Waveforms), 16FL Series

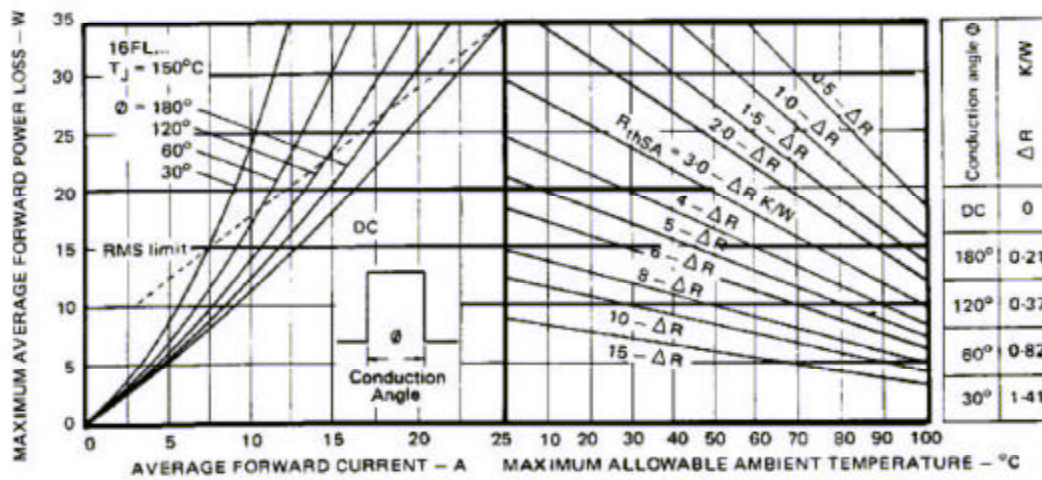

Fig. 10 - Current Rating Nomogram (Rectangular Waveforms), 16FL Series

40HFL, 70HFL, 85HFL Series

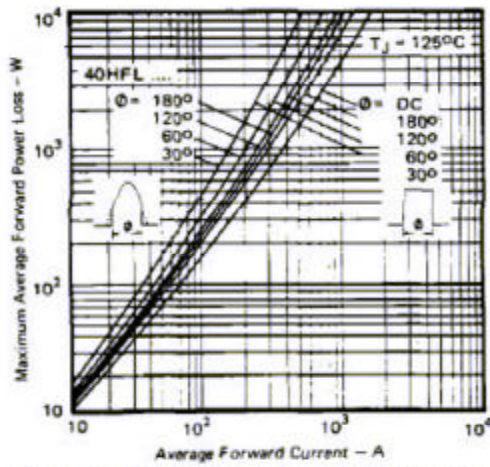

Fig. 8 - Maximum High Level Forward Power Loss Vs. Average Forward Current, 40HFL Series

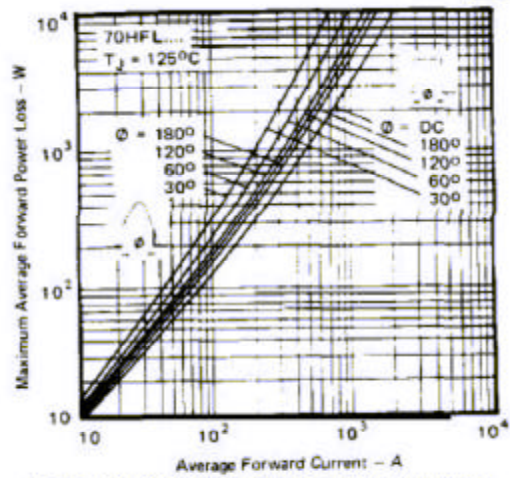

Fig. 9 - Maximum High Level Forward Power Loss Vs. Average Forward Current, 70HFL Series

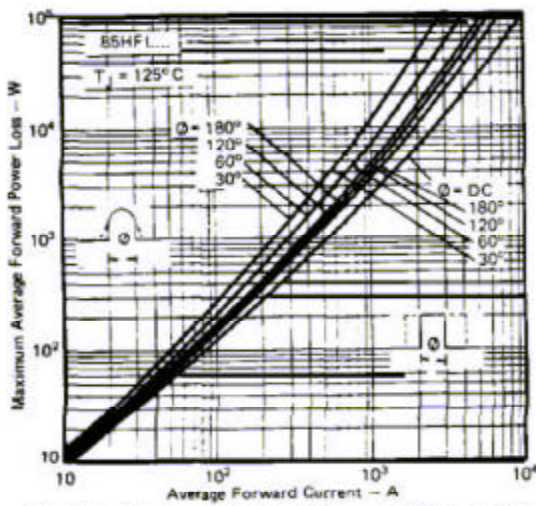

Fig. 10 - Maximum High Level Forward Power Loss Vs. Average Forward Current, 85HFL Series

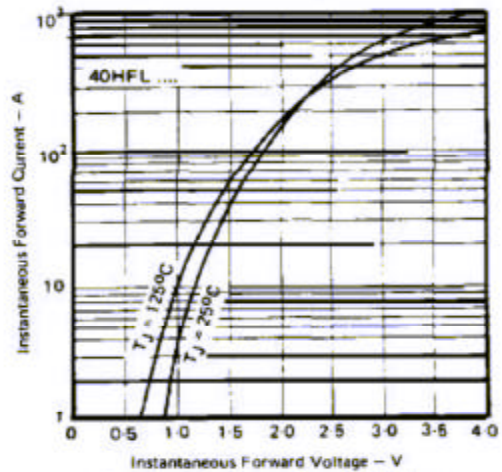

Fig. 11 - Maximum Forward Voltage Vs. Forward Current, 40HFL Series

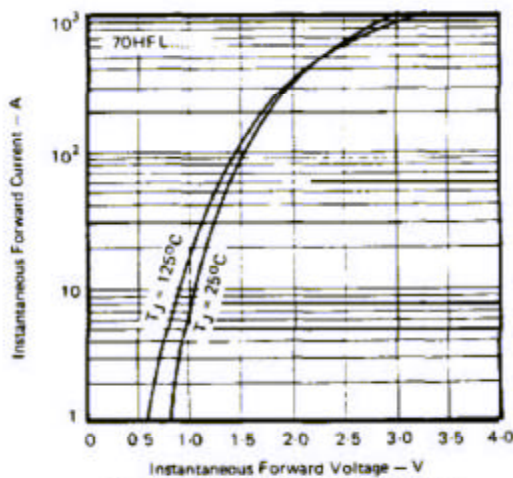

Fig. 12 - Maximum Forward Voltage Vs. Forward Current, 70HFL Series

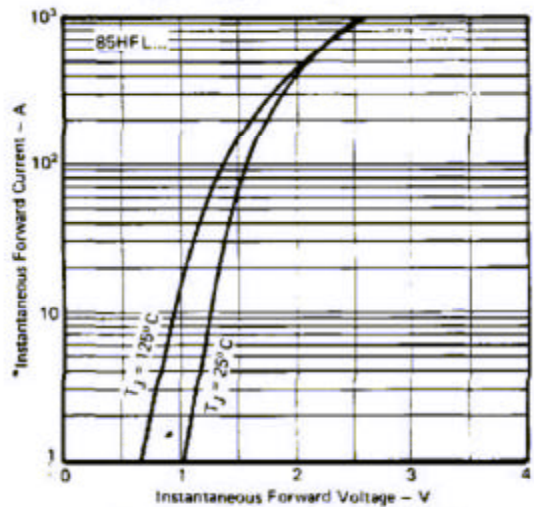

Fig. 13 - Maximum Forward Voltage Vs. Forward Current, 85HFL Series

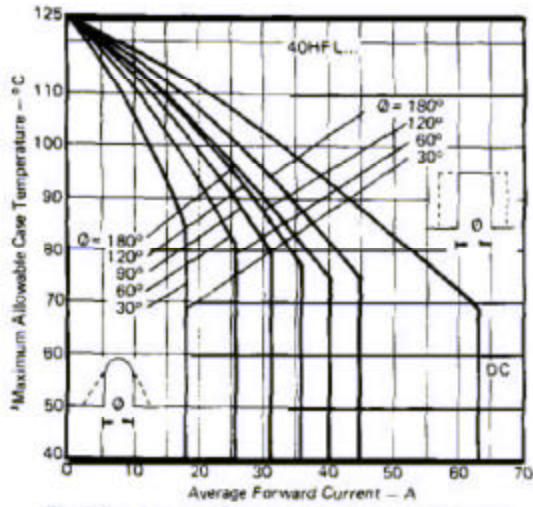

Fig. 14 — Average Forward Current Vs. Maximum Allowable Case Temperature, 40HFL Series

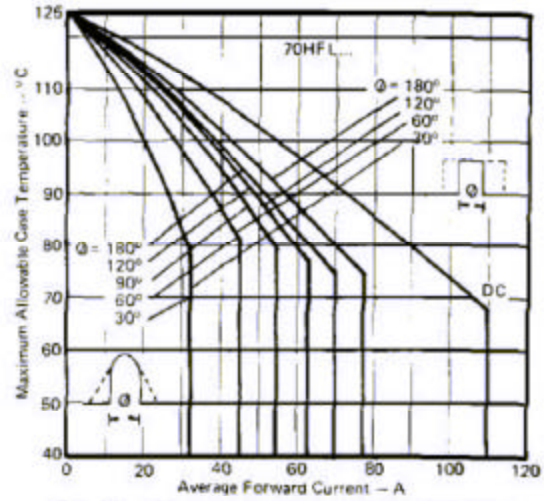

Fig. 15 — Average Forward Current Vs. Maximum Allowable Case Temperature, 70HFL Series

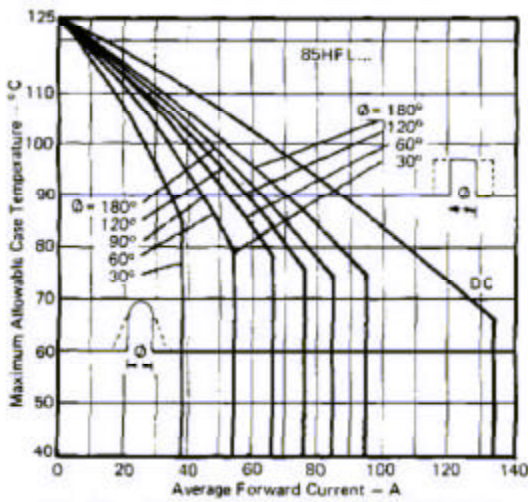

Fig. 16 — Average Forward Current Vs. Maximum Allowable Case Temperature, 85HFL Series

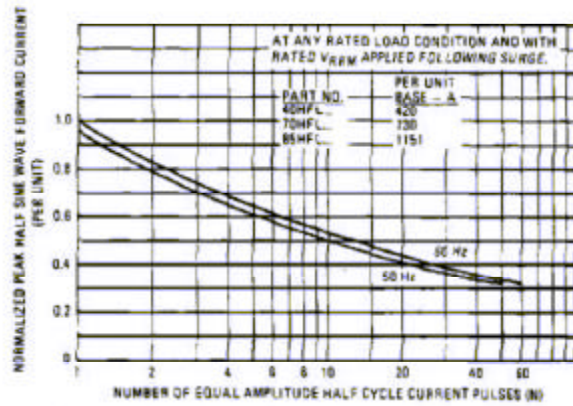

Fig. 17 — Maximum Non-Repetitive Surge Current Vs. Number of Current Pulses, All Series

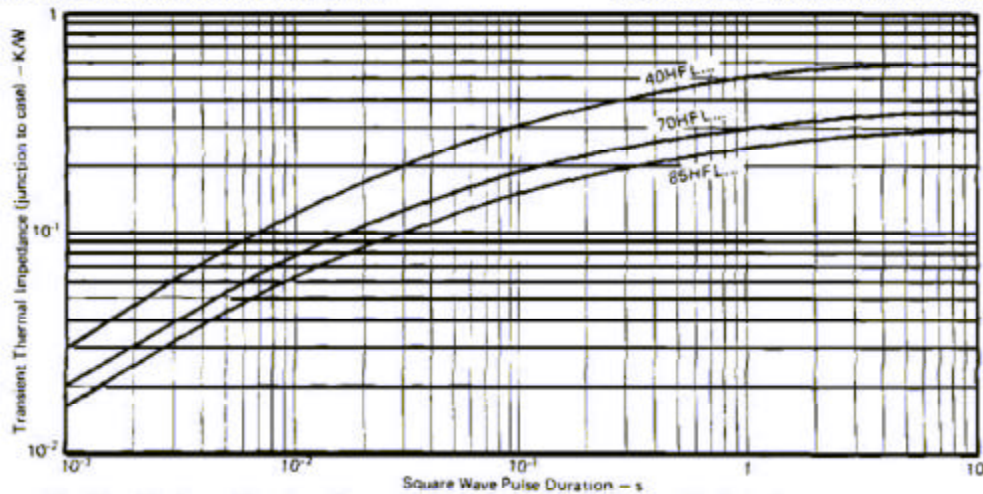

Fig. 18 — Maximum Transient Thermal Impedance, Junction-to-Case Vs. Pulse Duration, All Series

40HFL, 70HFL, 85HFL Series

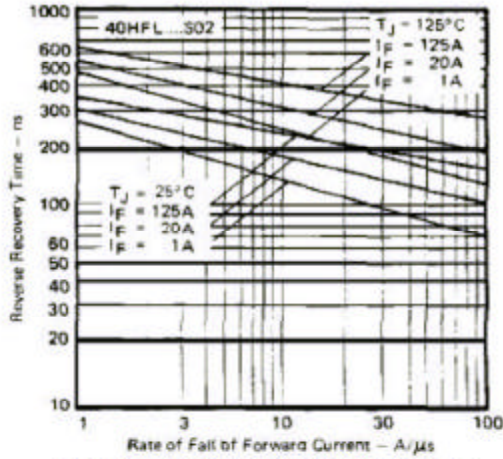

Fig. 19 — Typical Reverse Recovery Time Vs. Rate of Fall of Forward Current, 40HFL...S02 Series

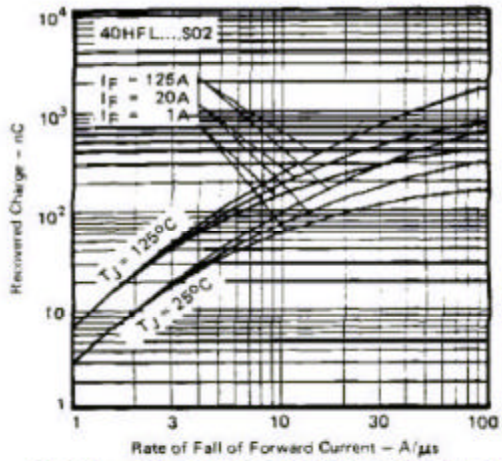

Fig. 20 — Typical Recovered Charge Vs. Rate of Fall of Forward Current, 40HFL...S02 Series

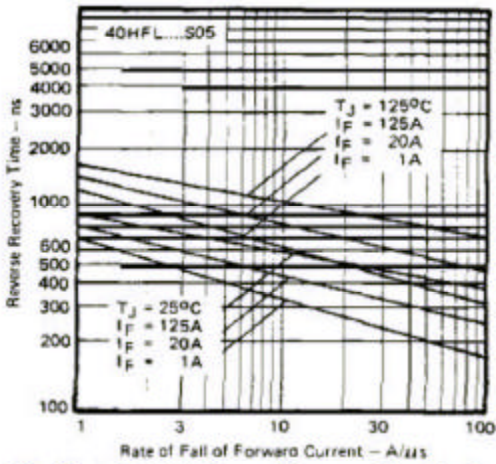

Fig. 21 — Typical Reverse Recovery Time Vs. Rate of Fall of Forward Current, 40HFL...S05 Series

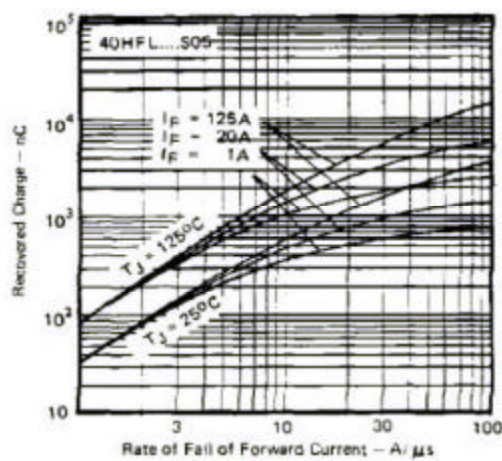

Fig. 22 — Typical Recovered Charge Vs. Rate of Fall of Forward Current, 40HFL...S05 Series

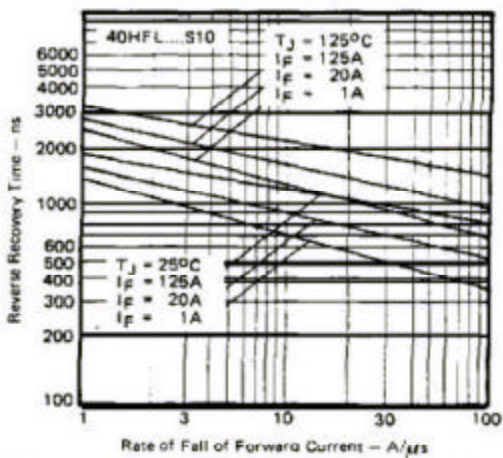

Fig. 23 — Typical Reverse Recovery Time Vs. Rate of Fall of Forward Current, 40HFL...S10 Series

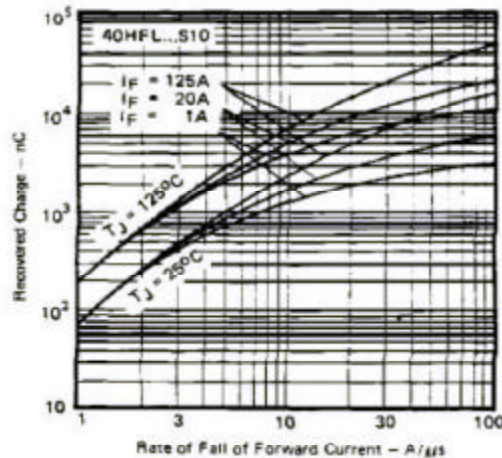

Fig. 24 — Typical Recovered Charge Vs. Rate of Fall of Forward Current, 40HFL...S10 Series

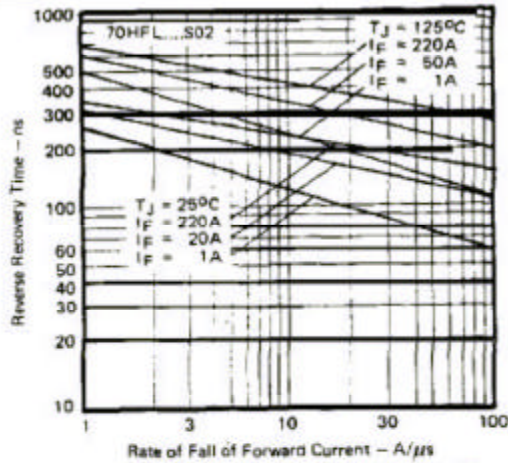

Fig. 25 — Typical Reverse Recovery Time Vs. Rate of Fall of Forward Current, 70HFL...S02 Series

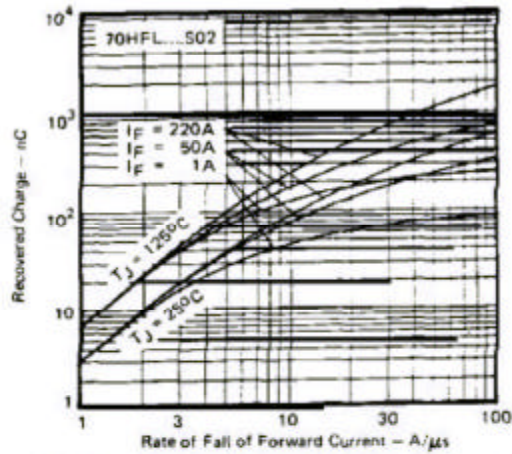

Fig. 26 — Typical Recovered Charge Vs. Rate of Fall of Forward Current, 70HFL...S02 Series

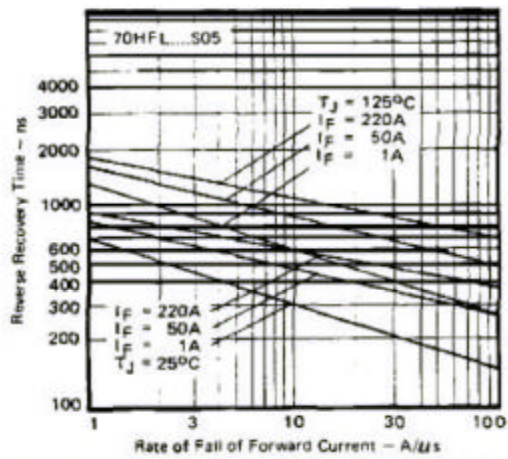

Fig. 27 — Typical Reverse Recovery Time Vs. Rate of Fall of Forward Current, 70HFL...S05 Series

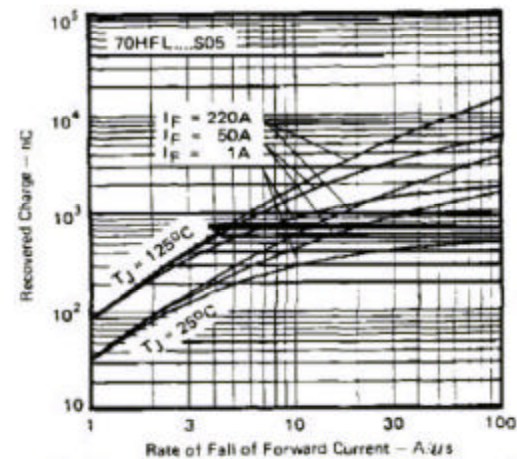

Fig. 28 — Typical Recovered Charge Vs. Rate of Fall of Forward Current, 70HFL...S05 Series

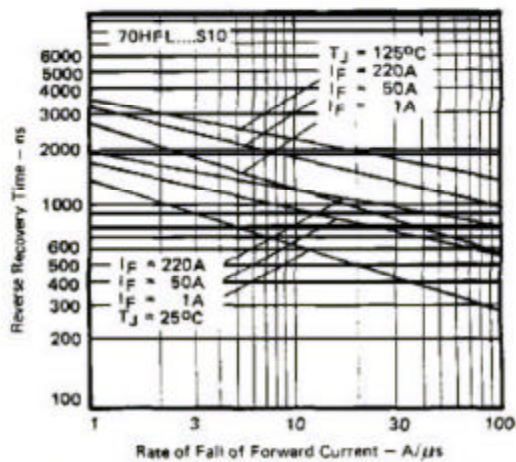

Fig. 29 — Typical Reverse Recovery Time Vs. Rate of Fall of Forward Current, 70HFL...S10 Series

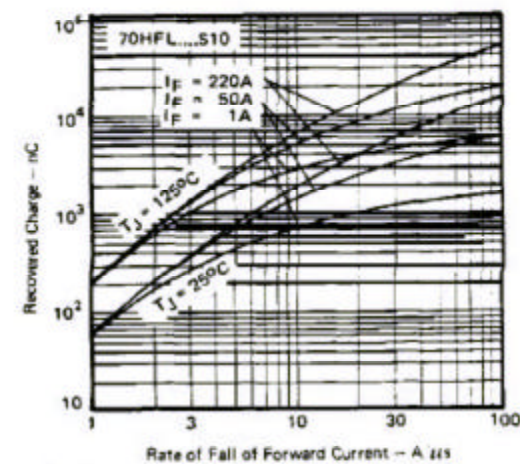

Fig. 30 — Typical Recovered Charge Vs. Rate of Fall of Forward Current, 70HFL...S10 Series

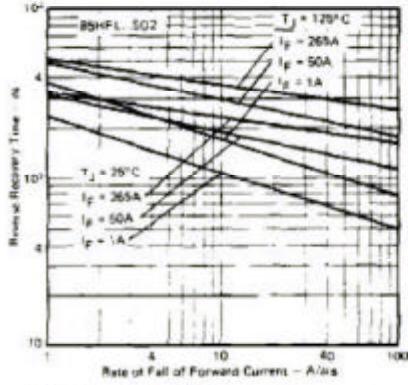

Fig. 31 – Typical Reverse Recovery Time Vs. Rate of Fall of Forward Current, 85HFL_S02 Series

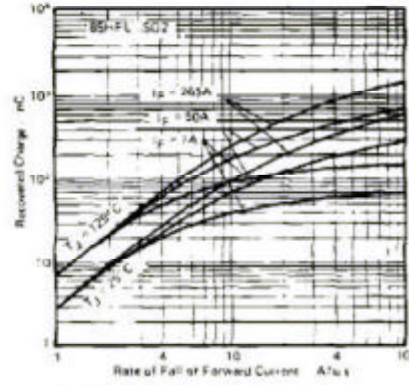

Fig. 32 – Typical Recovered Charge Vs. Rate of Fall of Forward Current, 85HFL_S02 Series

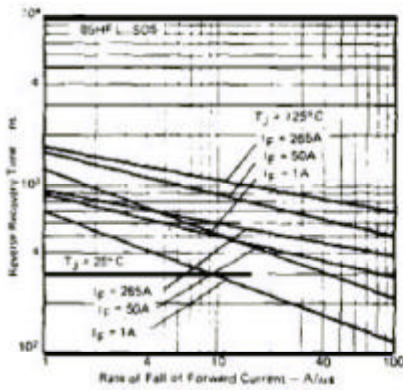

Fig. 33 – Typical Reverse Recovery Time Vs. Rate of Fall of Forward Current, 85HFL_S05 Series

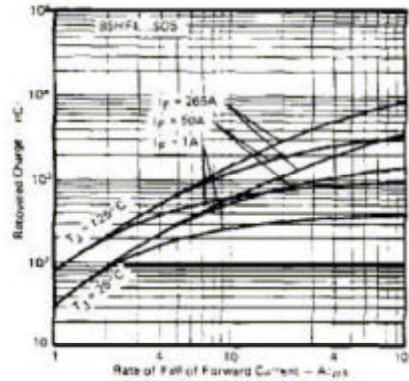

Fig. 34 – Typical Recovered Charge Vs. Rate of Fall of Forward Current, 85HFL_S05 Series

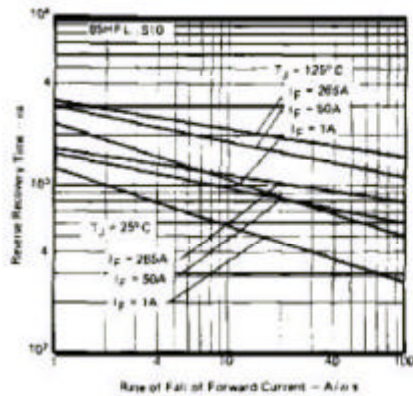

Fig. 35 – Typical Reverse Recovery Time Vs. Rate of Fall of Forward Current, 85HFL_S10 Series

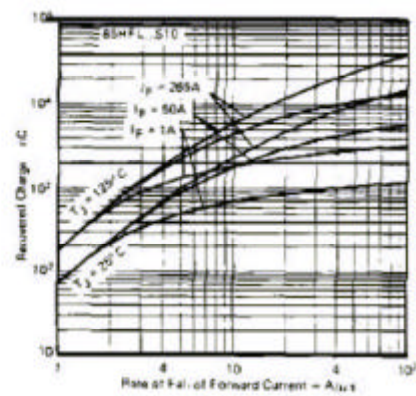

Fig. 36 – Typical Recovered Charge Vs. Rate of Fall of Forward Current, 85HFL_S10 Series