

# LUXEON 3535 HV

*High voltage package that reduces system BOM while achieving high efficacy*



## Introduction

The LUXEON 3535 HV mid-power product is an SMD solution that comes in both 24V and 48V configurations. This 3535 high voltage architecture allows for freedom of design when an LED project requires less bulky, more efficient drivers and an ultimate cost down on the LED system. Available in the 3535 platform, it enables interchangeability with other 3535 products and is offered in 1/9<sup>th</sup> micro color binning structure. As part of the 3535 platform, it enables interchangeability with other 3535 products and is offered in 1/9<sup>th</sup> micro color binning structure.

### Features

- High voltage
- Excellent current spreading
- High light output per package
- 1/9 micro color binning

### Benefits

- Lower current, more efficient and cost effective driver
- Leads to better light extraction
- Allows reduction in LED count
- Enables tight color control

### Key Applications

- Downlights
- Indoor Area Lighting
  - Wall Sconce
  - Wall Pack
- Lamps

# Table of Contents

General Information .....	2
Product Nomenclature .....	2
Average Lumen Maintenance Characteristics .....	2
Environmental Compliance .....	2
Product Selection .....	3
Electrical Characteristics .....	3
Absolute Maximum Ratings .....	4
JEDEC Moisture Sensitivity .....	4
Reflow Soldering Characteristics .....	5
Mechanical Dimensions and Package Information .....	6
Solder Pad Design .....	7
Package Information .....	7
Characteristic Curves .....	8
Relative Spectral Distribution vs. Wavelength .....	8
Relative Light Output Characteristics over Junction Temperature .....	8
Typical Forward Current Characteristics .....	9
Forward Current vs. Forward Voltage .....	9
Typical Light Output Characteristics .....	10
Typical Radiation Patterns .....	11
Radiation Pattern in Cartesian Coordinate System .....	11
Radiation Pattern in Polar Coordinate System .....	11
Emitter Packaging .....	12
Emitter Reel Packaging .....	13
Product Binning and Labeling .....	14
Flux Bin Labeling .....	14
Flux Bins .....	15
Forward Voltage Bins .....	15
Color Bin Structure .....	16

# General Information

## Product Nomenclature

LUXEON 3535 HV is tested and binned at  $T_j = 25^\circ\text{C}$  with a drive current of 15 mA DC. The part number designation is explained as follows:

L 13 5 - A A B B C D H V 0 0 0 0 1

Where:

- A — designates CCT (2700K = 27)
- B — designates CRI (70, 80 and 90)
- C — designates attribute ( 0 )
- D — designates voltage (A=12V, B=24V, C=48V)

For example, a white LUXEON 3535 HV 4000K/80 CRI 24V emitter has the following part number:

L 13 5 - 4 0 8 0 0 W B H V 0 0 0 0 1

## Average Lumen Maintenance Characteristics

The LUXEON 3535 HV is being tested in accordance with LM-80 standards. Please contact your Philips Lumiled's TSM or sales person for more detailed information.

## Environmental Compliance

Philips Lumileds is committed to providing environmentally friendly products to the solid-state lighting market. LUXEON 3535 HV is compliant to the European Union directives on the restriction of hazardous substances in electronic equipment, namely the RoHS and REACH directives. Philips Lumileds will not intentionally add the following restricted material to the LUXEON 3535 HV L135-XX800XHV00001: lead, mercury, cadmium, hexavalent chromium, polybrominated biphenyls (PBB) or polybrominated diphenyl ethers (PBDE).

# Product Selection

## Product Selection Guide for LUXEON 3535 HV LEDs Junction Temperature = 25°C

Table 1.

Voltage	Nominal CCT	Part Number	Luminous Flux (lm) <sup>[1]</sup> @ 15 mA		Luminous Flux (lm) <sup>[1]</sup> @ 20 mA	CRI <sup>[1]</sup>	Rth (°C/W)	
			Minimum	Typical	Typical	Minimum	Typical	
24	2700K	L135-27800BHV00001	37	41	53	80	25	
24	3000K	L135-30800BHV00001	39	43	55	80	25	
24	4000K	L135-40800BHV00001	42	48	60	80	25	
24	5000K	L135-50800BHV00001	42	48	60	80	25	
48	2700K	L135-27800CHV00001	71	80	102	80	14	
48	3000K	L135-30800CHV00001	75	84	107	80	14	
48	4000K	L135-40800CHV00001	83	93	120	80	14	
48	5000K	L135-50800CHV00001	83	93	120	80	14	

Notes for Table 1:

1. Philips Lumileds maintains a tolerance of ± 7.5% on luminous flux and ± 2 on CRI measurements.

## Electrical Characteristics

### Electrical Characteristics for LUXEON 3535 HV LEDs Junction Temperature = 25°C, Test Current = 15 mA

Table 2.

Part Number	Forward Voltage $V_f$ (V)			Temperature Coefficient of Forward Voltage between 25°C and 85°C $\Delta V_f / \Delta T_j$ (mV/°C)
	Minimum	Typical	Maximum	
L135-27800BHV00001 L135-30800BHV00001 L135-40800BHV00001 L135-50800BHV00001	22	24	26	-13
L135-27800CHV00001 L135-30800CHV00001 L135-40800CHV00001 L135-50800CHV00001	44	48	52	-26

Notes for Table 2:

1. Forward voltage test tolerance: ± 0.1 volts.

# Absolute Maximum Ratings

Table 3.

Parameter	Maximum Performance
DC Forward Current <sup>[1]</sup>	30 mA
Peak Pulsed Forward Current <sup>[2]</sup>	40 mA
LED Junction Temperature <sup>[1]</sup>	125°C
ESD Sensitivity	< 2000V Human Body Model (HBM) Class 2A JS-001-2012
Operating Case Temperature at 15 mA	-40°C - 105°C
Storage Temperature	-40°C - 105°C
Soldering Temperature	JEDEC 020D 260°C
Allowable Reflow Cycles	3
Reverse Voltage (Vr)	n/a

Notes for Table 3:

1. Ripple current with a frequency of 50-150 Hz is allowed as long as the average of the current waveform is below 30 mA and the maximum of the current waveform is lower than 40mA.
2. At 10% duty cycle and pulse width 10ms.
3. LUXEON 3535 HV LEDs are not designed to be driven in reverse bias.
4. At a maximum reverse current of 10 µA.

# JEDEC Moisture Sensitivity

Table 4.

Level	Floor Life		Soak Requirements Standard	
	Time	Conditions	Time	Conditions
2	1 year	≤ 30°C / 60% RH	168 Hrs. ± 5/0 Hrs.	≤85°C / 60% RH

# Reflow Soldering Characteristics

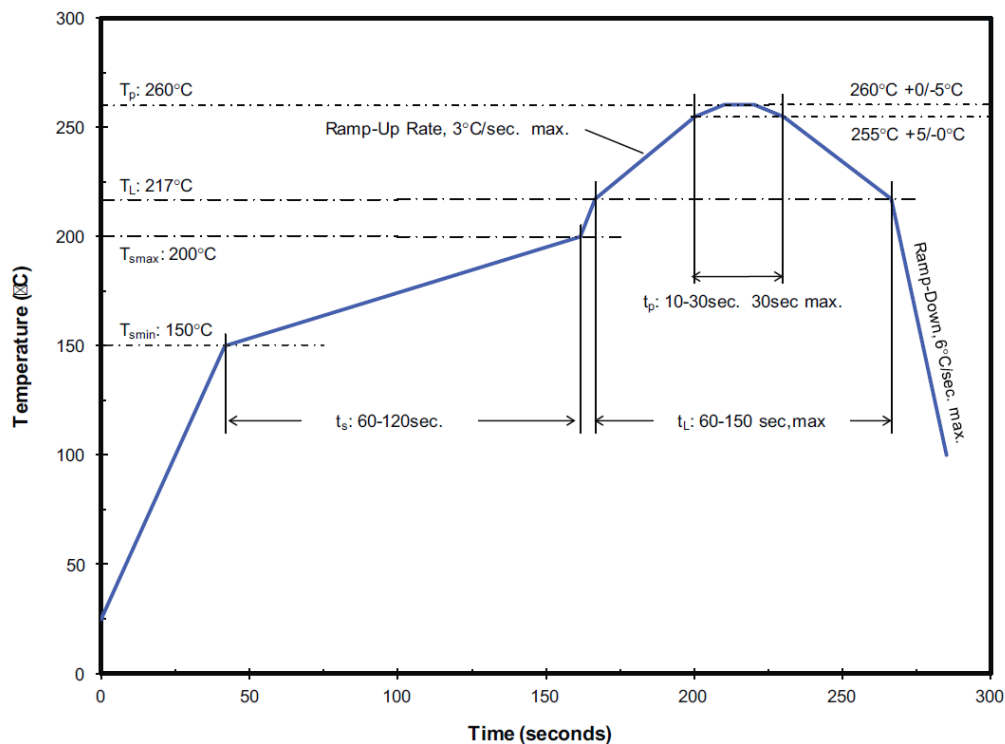

Figure 1. Temperature profile for Table 5.

Table 5. Reflow Profile in Accordance with J-Std-020D

Profile Feature	Lead Free Assembly
Preheat/Soak:	
Temperature Min ( $T_{smin}$ )	150°C
Temperature Max ( $T_{smax}$ )	200°C
Maximum Time ( $t_s$ ) from $T_{smin}$ to $T_{smax}$	120 seconds
Ramp-up Rate ( $T_L$ to $T_p$ )	3°C / second
Liquidous Temperature ( $T_L$ )	217°C
Maximum Time ( $t_L$ ) Maintained $T_L$	150 seconds
Maximum Peak Package Body Temperature ( $T_p$ )	260°C
Time ( $t_p$ ) within 5°C of the specified temperature ( $T_c$ )	10 - 30 seconds
Maximum Ramp-Down Rate ( $T_p$ to $T_L$ )	6°C / second
Maximum Time 25°C to Peak Temperature	8 minutes

Notes for Table 5:

- All temperatures refer to the application Printed Circuit Board (PCB), measured on the surface adjacent to the package body.

# Mechanical Dimensions and Package Information

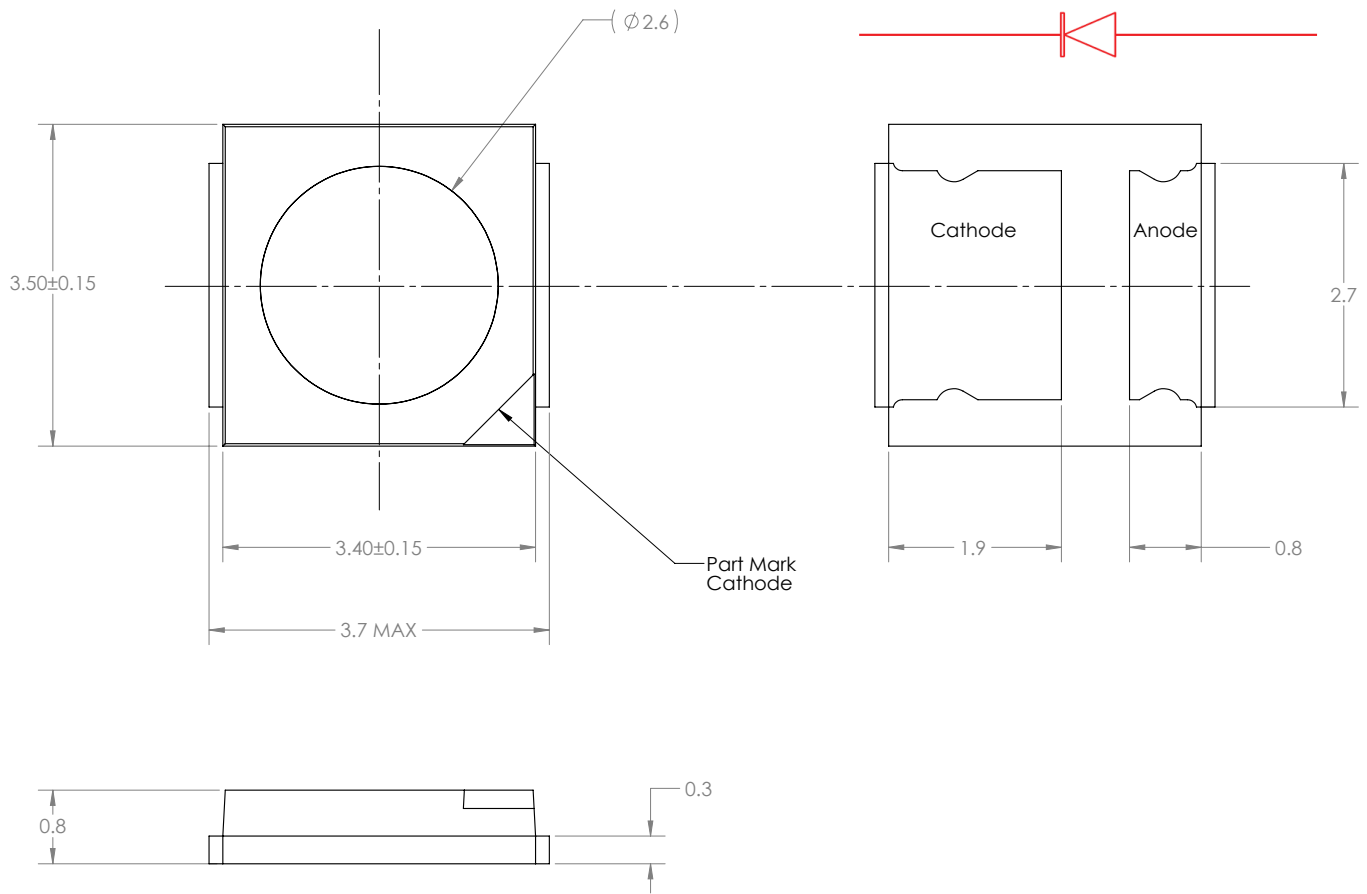

Figure 2.

Notes for Figure 2:

1. All dimensions are in millimeters.
2. Tolerance  $\pm 0.10$ mm.

## Solder Pad Design

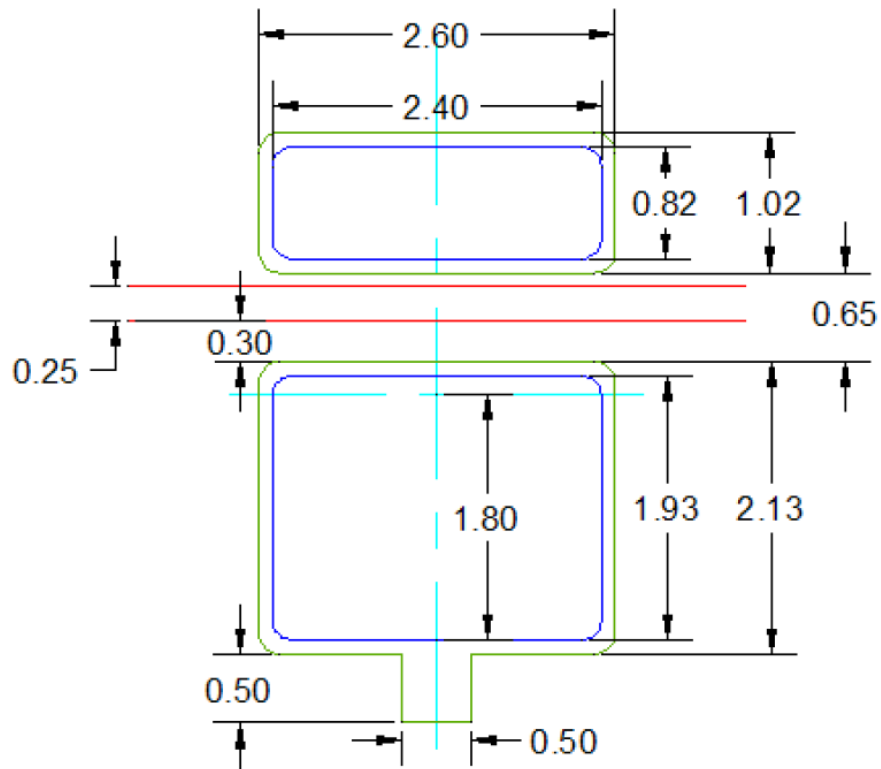

Figure 3. Solder pad layout.

Notes for Figure 3:

1. The drawing above shows the recommend solder pad layout on the Printed Circuit Board (PCB).
2. All dimensions are in millimeters.
3. Application Brief AB203 provides details for this layout. In addition, the .drawing files are available at [www.philipslumileds.com](http://www.philipslumileds.com) and [www.philipslumileds.cn.com](http://www.philipslumileds.cn.com).

## Package Information

Table 6. Package Information for L135-xx80-0xHV-00001

Material/Component	Specification
Lead Frame Base	Copper Alloy
Package Body	High Temperature Thermal Plastic
Encapsulate	Silicone Resin, with Phosphor
Weight	0.08gram



# Characteristic Curves

## Relative Spectral Distribution vs. Wavelength

Junction Temperature = 25°C; Test Current = 15 mA

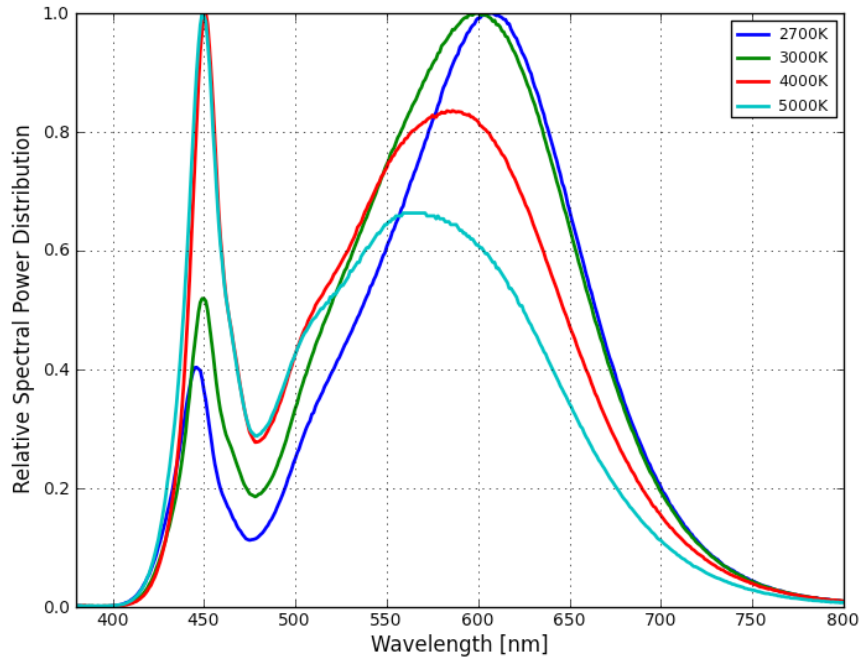

Figure 4. Color spectrum, L135-xx80-0xHV-00001.

## Relative Light Output Characteristics over Junction Temperature

Test Current = 15 mA

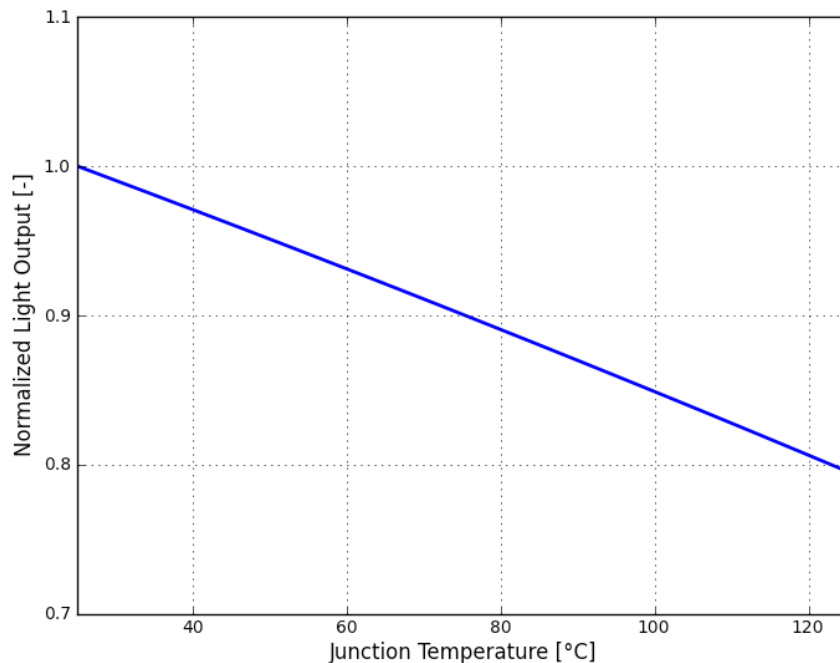

Figure 5. Relative light output vs. junction temperature, L135-xx80-0xHV-00001.

# Typical Forward Current Characteristics

Forward Current vs. Forward Voltage for L135-xx80-0BHV-00001  
Junction Temperature = 25°C

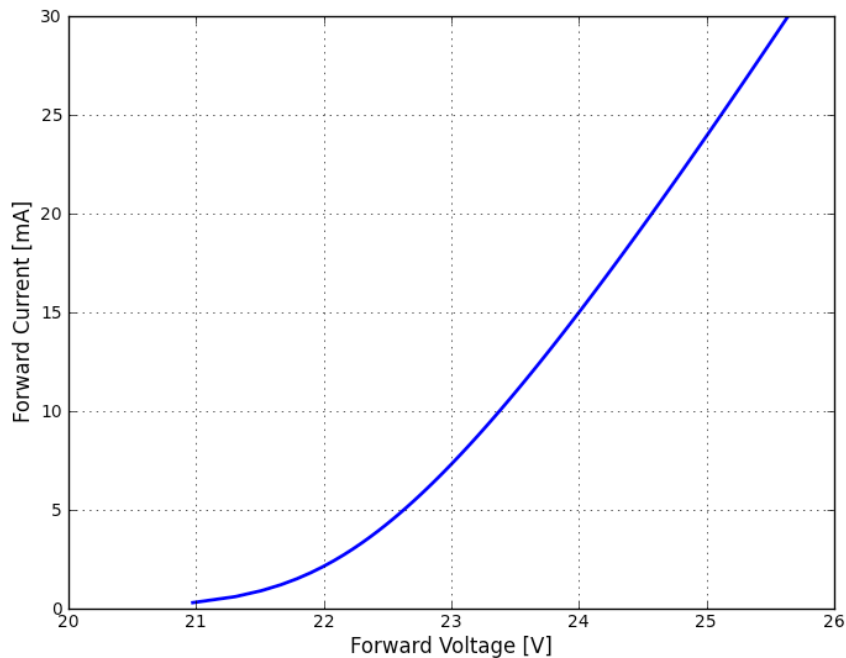

Figure 6. Typical forward current vs. forward voltage, L135-xx80-0BHV-00001.

Forward Current vs. Forward Voltage for L135-xx80-0CHV-00001  
Junction Temperature = 25°C

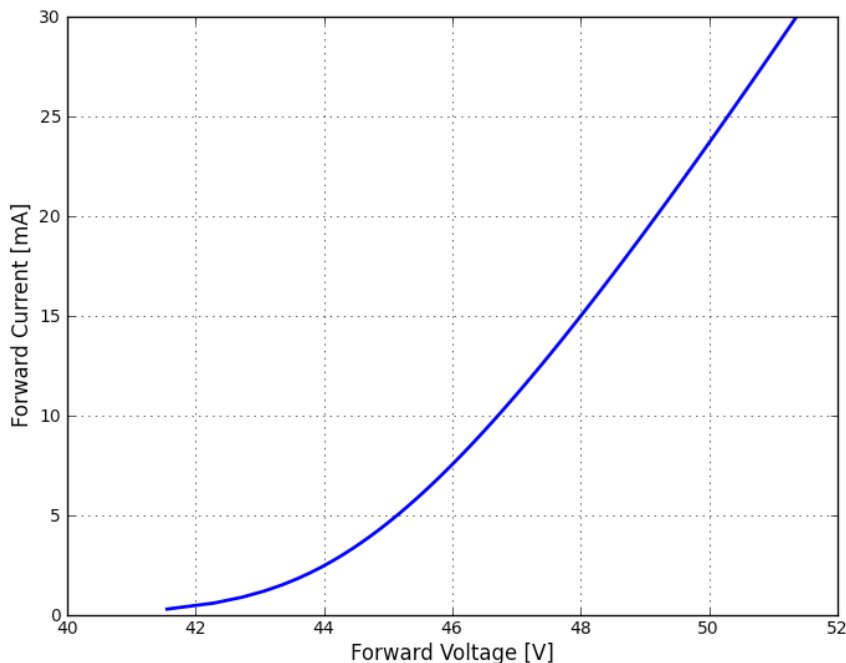

Figure 7. Typical forward current vs. forward voltage, L135-xx80-0CHV-00001.

# Typical Light Output Characteristics

Relative Light Output vs. Forward Current  
Junction Temperature = 25°C

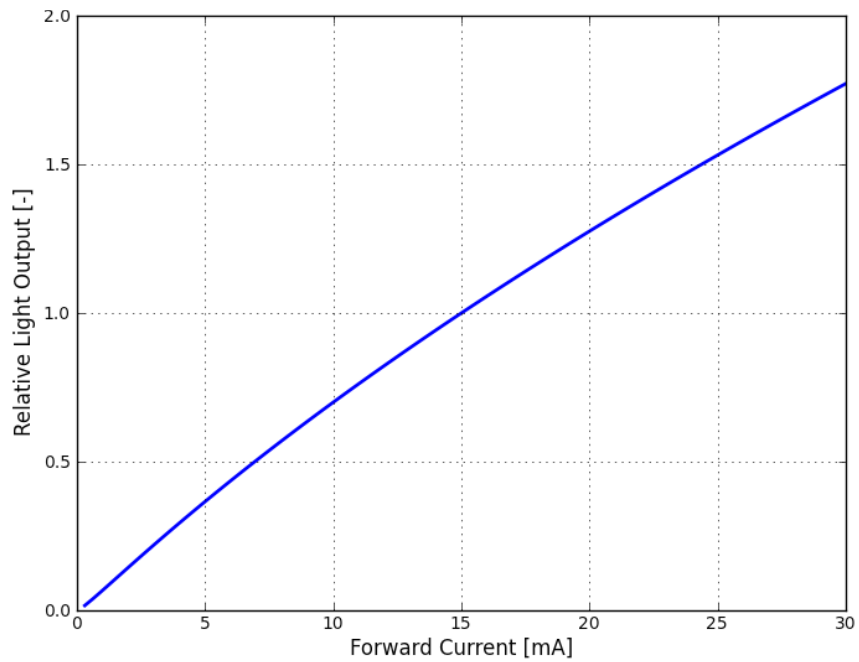

Figure 8. Relative light output vs. forward current, L135-xx80-0xHV-00001.

# Typical Radiation Patterns

## Radiation Pattern in Cartesian Coordinate System

Junction Temperature = 25°C

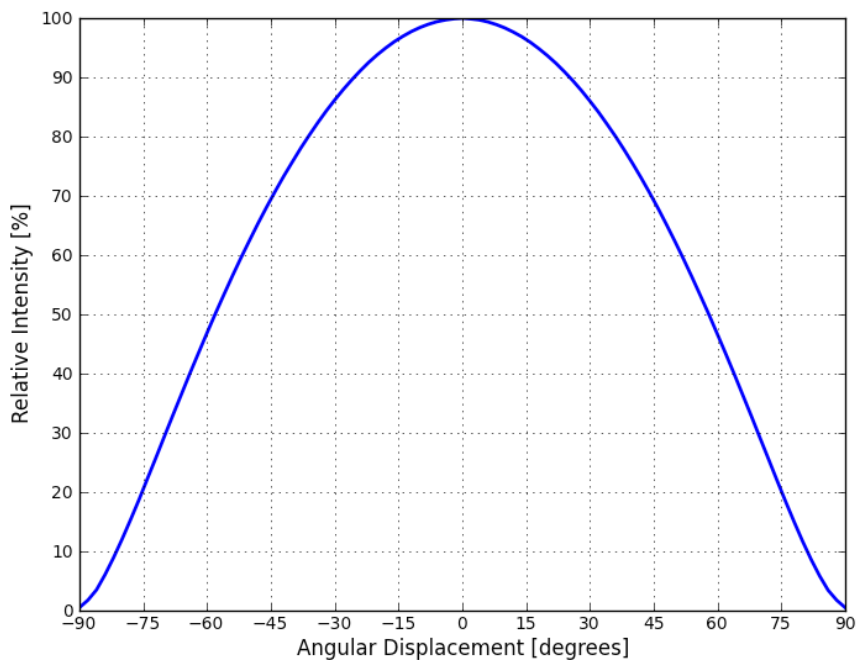

Figure 9. Typical spatial radiation pattern, L135-xx80-0xHV-00001.

## Radiation Pattern in Polar Coordinate System

Junction Temperature = 25°C

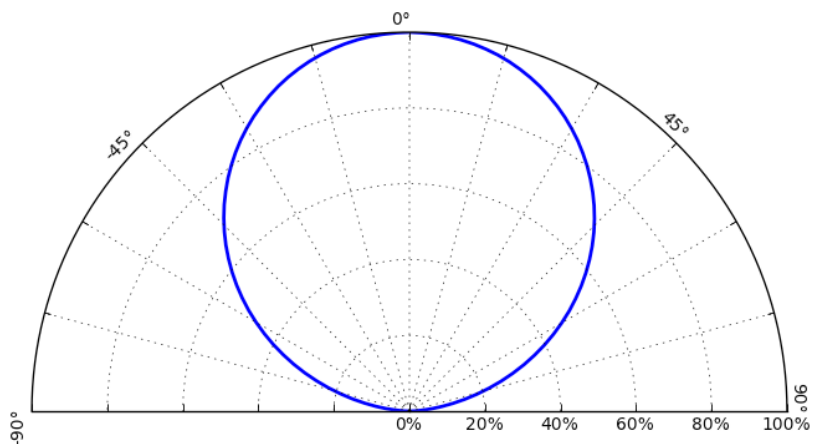

Figure 10. Typical polar radiation pattern, L135-xx80-0xHV-00001.

# Emitter Packaging

## Emitter Pocket Tape Packaging

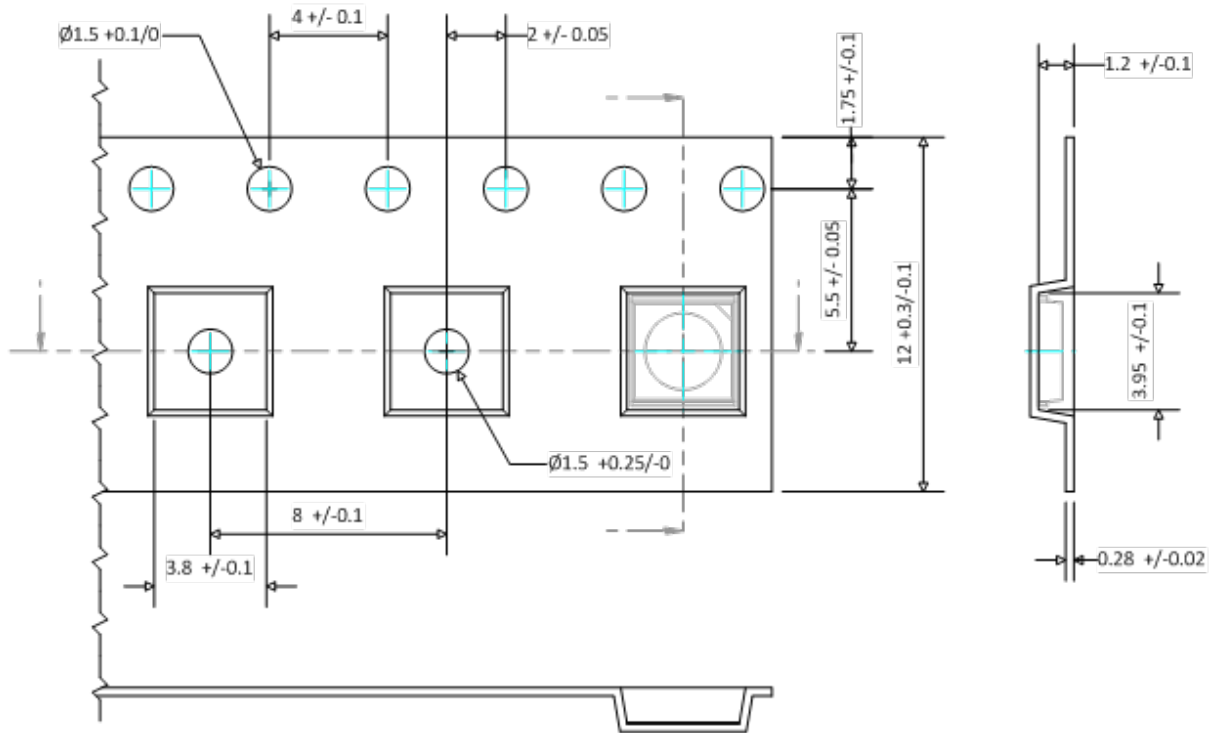

Figure 11. Emitter pocket tape packaging.

### Notes for Figure 11:

1. All dimensions are in millimeters.
2. Empty component pockets sealed with top cover tape.
3. The maximum number of consecutive missing LEDs is two.

# Emitter Reel Packaging

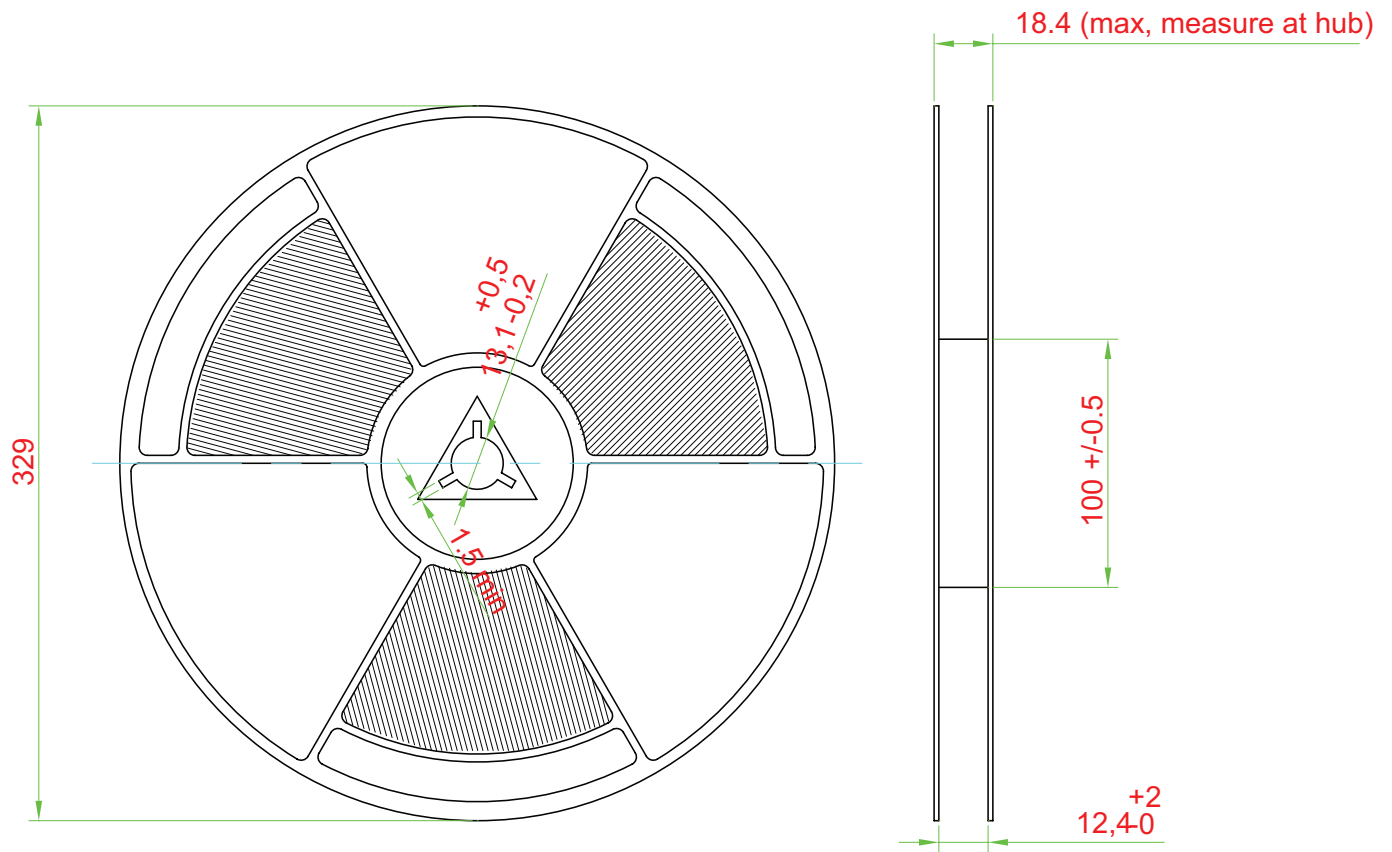

Figure 12. Emitter reel packaging.

## Notes for Figure 12:

1. All dimensions are in millimeters.
2. Empty component pockets sealed with top cover tape.
3. 13 inch reel-5000 pieces per reel.
4. Minimum packing quantity is 5000 pieces.
5. The maximum number of consecutive missing LEDs is two.
6. In accordance with EIA-481-1-B specification.

# Product Binning and Labeling

## Purpose of Product Binning

In the manufacturing of semiconductor products, there is a variation of performance around the average values given in the technical data sheets. For this reason, Philips Lumileds bins the LED components for luminous flux, color and forward voltage ( $V_f$ ).

## Decoding Product Bin Labeling

LUXEON mid-power emitters are labeled using a four digit alphanumeric code (CAT code) depicting the bin values for emitters packaged on a single reel. All emitters packaged within a reel are of the same 3-variable bin combination. Using these codes, it is possible to determine optimum mixing and matching of products for consistency in a given application.

Reels of 2700K, 3000K, 3500K, 4000K, 5000K emitters are labeled with the CAT code following the format below.

ABCD

Where:

A — Flux bin (L etc.)

B & C — Color bin (For example 5J, 5D, 5L, 5M)

D —  $V_f$  bin

## Luminous Flux Bins

Table 7 and Table 8 list the standard photometric luminous flux bins for LUXEON mid-power emitters (tested and binned at 15 mA). Although several bins are outlined, product availability in a particular bin varies by production run and by product performance. Not all bins are available in all colors. Please contact your Philips Lumileds representative for the L135-xx80-xBHV-00001 & L135-xx80-xCHV-00001 flux bins.

## Flux Bin Labeling

Table 7. Flux Bins for L135-xx80-0BHV-00001

Bin Code	Minimum Photometric Flux (lm)	Maximum Photometric Flux (lm)
K	28	32
L	32	36
M	36	40
P	40	44
Q	44	48
R	48	52
S	52	56

Note for Table 7:

1. Tested and binned at 25°C,  $I_f = 15$  mA. Tester tolerance:  $\pm 7.5\%$ .

# Flux Bins

**Table 8. Flux Bins for L135-xx80-OCHV-00001**

Bin Code	Minimum Photometric Flux (lm)	Maximum Photometric Flux (lm)
B	60	65
C	65	70
D	70	75
E	75	80
F	80	85
G	85	90
H	90	95

Note for Table 8:

1. Tested and binned at 25°C,  $I_f = 15$  mA. Tester tolerance:  $\pm 7.5\%$ .

# Forward Voltage Bins

**Table 9.  $V_f$  Bins for L135-xx80-OBHV-00001**

Bin Code	Minimum Forward Voltage (V)	Maximum Forward Voltage (V)
F	22.0	22.8
G	22.8	23.6
H	23.6	24.4
I	24.4	25.2
J	25.2	26.0

Note for Table 9:

1. Tested and binned at 25°C,  $I_f = 15$  mA. Tester tolerance:  $\pm 1.5\%$ .

**Table 10.  $V_f$  Bins for L135-xx80-OCHV-00001**

Bin Code	Minimum Forward Voltage (V)	Maximum Forward Voltage (V)
L	44.0	45.6
M	45.6	47.2
P	47.2	48.8
Q	48.8	50.4
R	50.4	52.0

Note for Table 10:

1. Tested and binned at 25°C,  $I_f = 15$  mA. Tester tolerance:  $\pm 1.5\%$ .



# Color Bin Structure

## L135-2780-0xHV-00001 Color Bin Structure

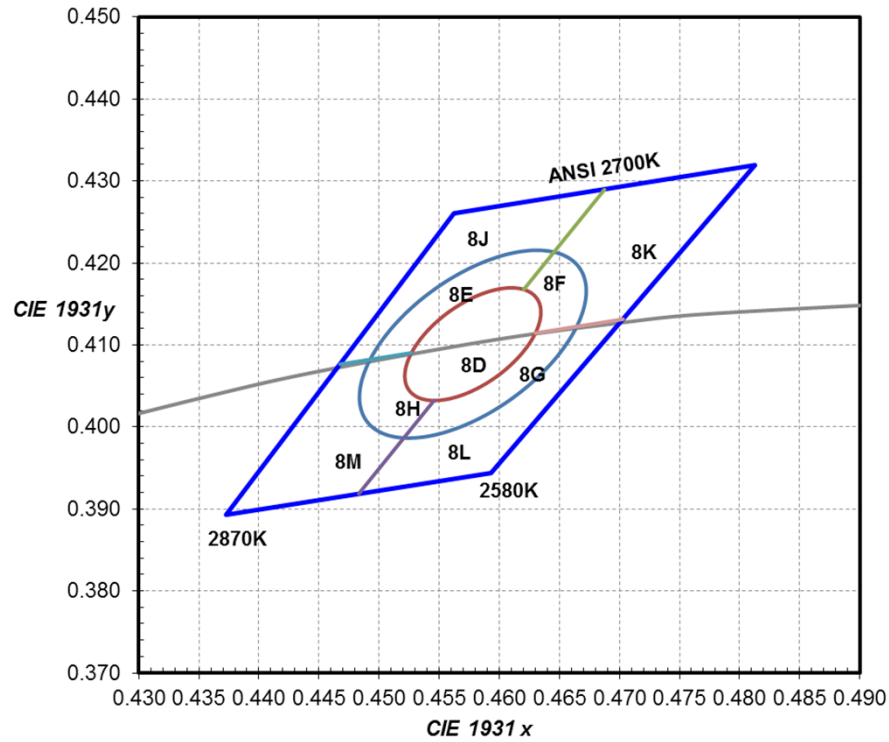

Figure 13. 2700K 1/9<sup>th</sup> color bin structure.

Table 11.

Nominal ANSI CCT	Color Space	Target Center Point (cx, cy)	Major Axis, a	Minor Axis, b	Ellipse Rotation Angle
2700K	Single 3-step MacAdam ellipse	(0.4578, 0.4101)	0.00810	0.00420	53.70°
2700K	Single 5-step MacAdam ellipse	(0.4578, 0.4101)	0.01350	0.00700	53.70°

# Color Bin Structure, Continued

## L135-2780-0xHV-00001 Color Bin Structure

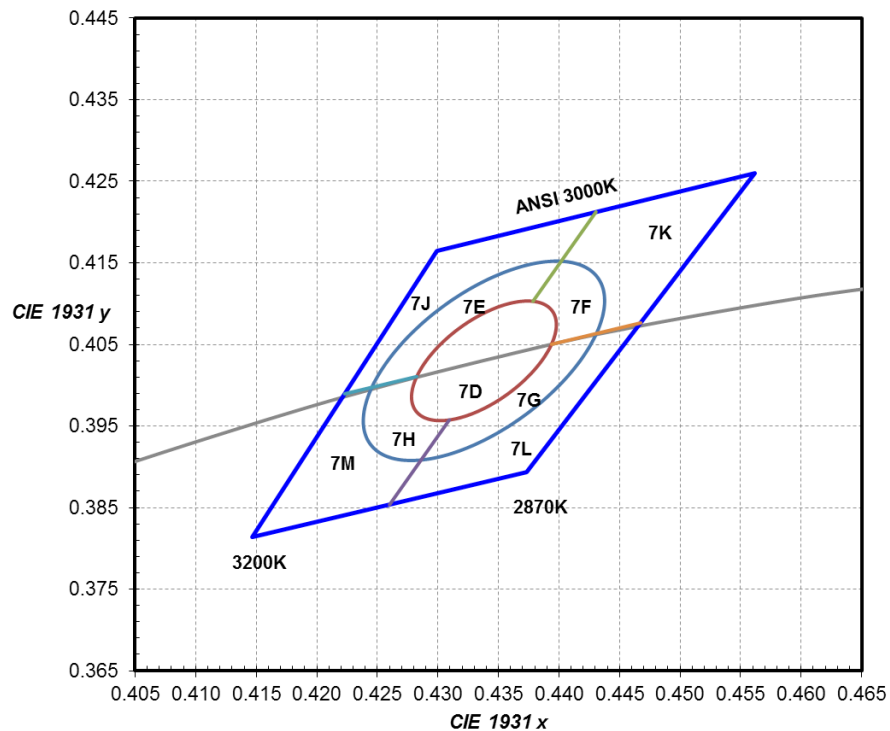

Figure 14. 3000K 1/9<sup>th</sup> color bin structure.

Table 12.

Nominal ANSI CCT	Color Space	Target Center Point (cx, cy)	Major Axis, a	Minor Axis, b	Ellipse Rotation Angle
3000K	Single 3-step MacAdam ellipse	(0.4338, 0.403)	0.00834	0.00408	53.22°
3000K	Single 5-step MacAdam ellipse	(0.4338, 0.403)	0.01390	0.00680	53.22°

# Color Bin Structure, Continued

## L135-4080-0XHV-00001 Color Bin Structure

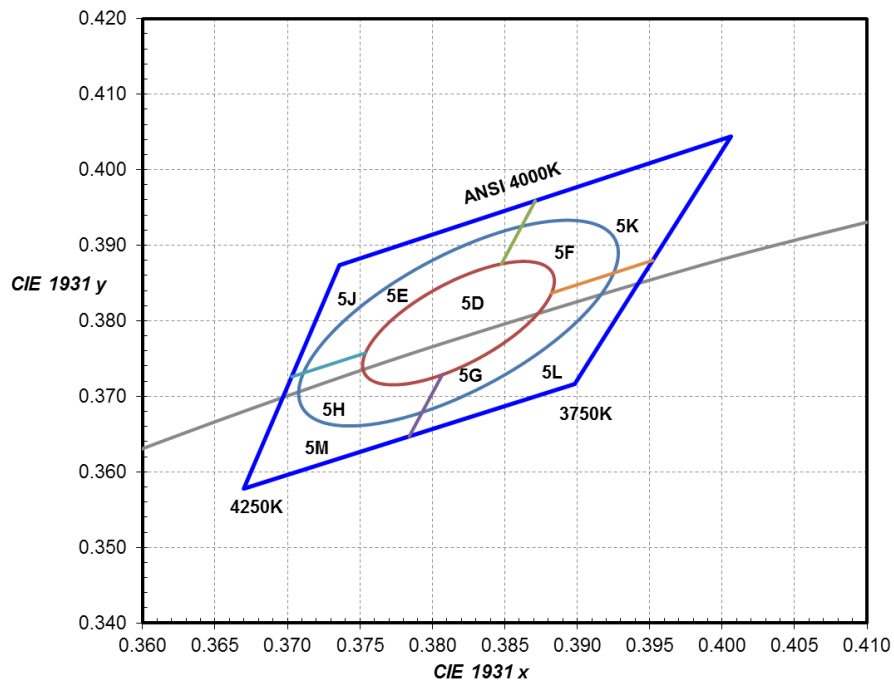

Figure 15. 4000K 1/9<sup>th</sup> color bin structure.

Table 13.

Nominal ANSI CCT	Color Space	Target Center Point (cx, cy)	Major Axis, a	Minor Axis, b	Ellipse Rotation Angle
4000K	Single 3-step MacAdam ellipse	(0.3818, 0.3797)	0.00939	0.00402	53.72°
4000K	Single 5-step MacAdam ellipse	(0.3818, 0.3797)	0.01565	0.00670	53.72°

# Color Bin Structure, Continued

## L135-5080-0XHV-00001 Color Bin Structure

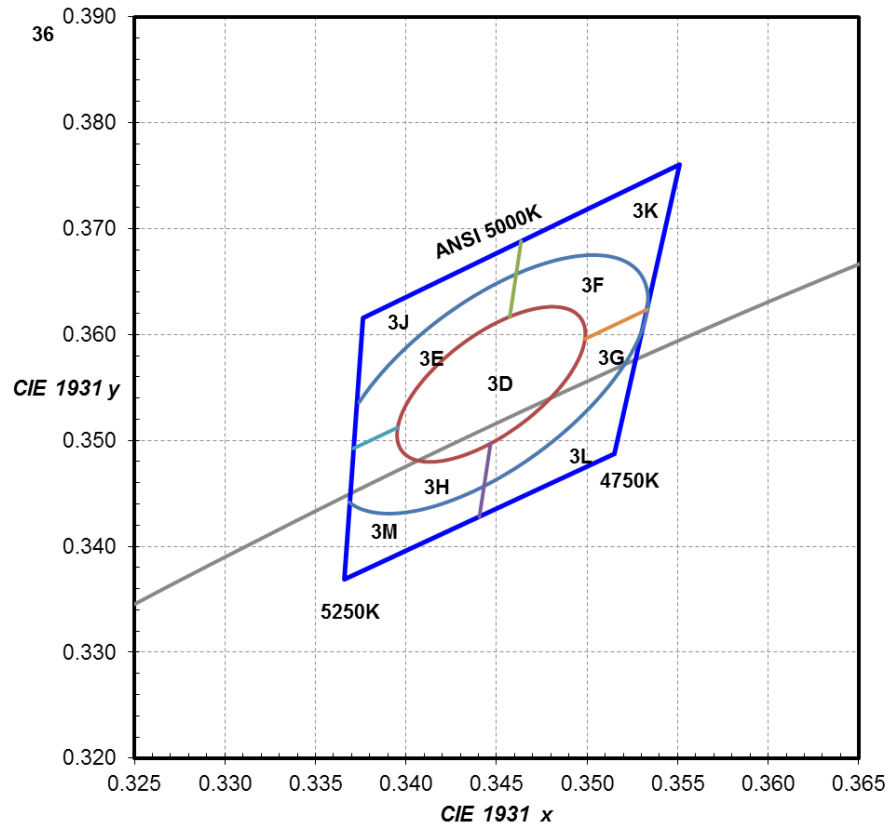

Figure 16. 5000K 1/9<sup>th</sup> color bin structure.

Table 14.

Nominal ANSI CCT	Color Space	Target Center Point (cx, cy)	Major Axis, a	Minor Axis, b	Ellipse Rotation Angle
5000K	Single 3-step MacAdam ellipse	(0.3447, 0.3553)	0.00822	0.00354	59.62°
5000K	Single 5-step MacAdam ellipse	(0.3447, 0.3553)	0.01370	0.00590	59.62°

## Who We Are

Philips Lumileds focuses on one goal: Creating the world's highest performing LEDs. The company pioneered the use of solid-state lighting in breakthrough products such as the first LED backlit TV, the first LED flash in camera phones, and the first LED daytime running lights for cars. Today we offer the most comprehensive portfolio of high quality LEDs and uncompromising service.

Philips Lumileds brings LED's qualities of energy efficiency, digital control and long life to spotlights, downlights, high bay and low bay lighting, indoor area lighting, architectural and specialty lighting as well as retrofit lamps. Our products are engineered for optimal light quality and unprecedented efficacy at the lowest overall cost. By offering LEDs in chip, packaged and module form, we deliver supply chain flexibility to the inventors of next generation illumination.

Philips Lumileds understands that solid state lighting is not just about energy efficiency. It is about elegant design. Reinventing form. Engineering new materials. Pioneering markets and simplifying the supply chain. It's about a shared vision. Learn more about our comprehensive portfolio of LEDs at [www.philipslumileds.com](http://www.philipslumileds.com).



Philips Lumileds Lighting Company shall not be liable for any kind of loss of data or any other damages, direct, indirect or consequential, resulting from the use of the provided information and data. Although Philips Lumileds Lighting Company has attempted to provide the most accurate information and data, the materials and services information and data are provided "as is" and Philips Lumileds Lighting Company neither warranties, nor guarantees the contents and correctness of the provided information and data. Philips Lumileds Lighting Company reserves the right to make changes without notice. You as user agree to this disclaimer and user agreement with the download or use of the provided materials, information and data.



©2014 Philips Lumileds Lighting Company. All rights reserved.  
LUXEON is a registered trademark of the Philips Lumileds Lighting Company in the United States and other countries.

[www.philipslumileds.com](http://www.philipslumileds.com)  
[www.philipslumileds.cn.com](http://www.philipslumileds.cn.com)

LUXEON 3535 HV Datasheet DS206 20140323